

çet-san®



2022-2

www.cet-san.com.tr

 ***çet-san***[®]

İçindekiler

- 1 Desire Serisi W. Otomat Kutuları
- 2 Eko Dekoratif & Nemli Yer W. Otomat Kutuları
- 3 Zayıf Akım Kutuları & Sıva Altı Sac W.Otomat Kutuları
- 4 Çok Amaçlı Dağıtım Panoları & Sayaç Kutuları
- 5 Ultraviole & Renkli & Metal Kablo Bağları
- 6 Kablo Bağları
- 7 Kroşeler & Dübelller
- 8 Vidalar
- 9 Şebeke & Ups Prizler - Data & Telefon Prizleri
- 10 ÇET-SAN 1. Kalite & Eko Yapışkanlı Kablo Kanalları
- 11 Renkli Kablo Kanalları
- 12 Delikli & Balıksırtı & İçten Kapaklı Kablo Kanalları
- 13 Polikarbonat Panolar
- 14 ABS Panolar & Otomat Panoları
- 15 Menholler & Rögar kapakları
- 16 Menholler & Rögar kapakları
- 17 Sıva Üstü Termoplastik Buatlar
- 18 Sıva Üstü Buatlar & Kofra & Posta Kutusu
- 19 Telefon & TV & Bilgisayar Aksesuarları
- 20 Telefon Modül Kutuları
- 21 Tavan ve Duvar Glob Armatürler
- 22 ECO & Polikarbonat Armatürler
- 23 Dekoratif E27 Duyulu Cam Armatürler & Sokak Armatürler & Hareket Sensörleri
- 24 180° & 360° E27 Duyulu Sensörlü Armatürler & Dekoratif Ledli Cam Armatürler
- 25 Lamparra
- 26 Lamparra
- 27 Kombinasyon Kutuları ABS & Eko
- 28 ABS Kombinasyon Kutuları & Uygulanabilir Prizler
- 29 Kasa & Buatlar Halogen Free
- 30 Kasa & Buatlar
- 31 Pano Spirali & Kablo Toplama Spirali & Koruge Boru
- 32 Kangal Borular & Dirsek & Muflar
- 33 Çelik Spiral & PVC İzoleli Çelik Spiral & Kılavuz Telli
- 34 Plastik Spiral & Polietilen & PP Polypropilen Spiraller
- 35 PVC Borular & Sustalar
- 36 Kroşeler & Rakorlar & Paspayları
- 37 Klemensler
- 38 Buat Klemensleri
- 39 Dağıtım Ünitesi
- 40 Topraklama Klemensleri & Bara & Raylar
- 41 İzolatörler
- 42 Ray Klemensler
- 43 İzoleli Kablo Yüksükleri & Terminalleri
- 44 Pabuçlar & Muflar & Sıkma Penseleri
- 45 Kapı Otomatikleri - Sinyal Lambaları - Buton Kutuları
- 46 Zil Butonları & Zil Çeşitleri
- 47 Fişler & Kontrol Kalemleri & Takım Çantaları
- 48 Duylar
- 49 İkaz Uyarı Sistemleri - EXIT (Çıkış) Lambaları
- 50 İkaz Uyarı Sistemleri
- 51 Donatılabilir Priz Blokları
- 52 Döşeme Altı Buatlar & Priz Kutuları
- 53 Sıva Üstü Anahtar Grubu & Priz Grubu
- 54 Aspiratörler
- 55 Aspiratörler
- 56 Aspiratörler
- 57 Reçineli & Isı Büzüşmeli Ek Muflar
- 58 Reçineli & Isı Büzüşmeli Ek Muflar
- 59 Şeffaf Reçineli Kablo Ek Mufları
- 60 Isı ile Daralan Makaronlar
- 61 Kauçuk Fiş & Prizler & Seyyar El Lambaları
- 62 CEE Norm Fiş & Prizler & Makaralar
- 63 Kauçuk Fiş & Prizler
- 64 Yassı Fiş Prizler & CEE Norm Fiş Prizler
- 65 CEE Norm Fiş - Prizler & Alüminyum Buatlar & Buton Kutuları
- 66 CEE Norm Fiş - Prizler & Alüminyum Buatlar & Buton Kutuları
- 67 Kablo Makaraları & El Lambaları
- 68 Yeni Ürünlerimiz

Desire Serisi W.Otomat Kutuları - KLEMENSLİ



KOD	CİNSİ	KOLİ	FİYAT
WK.05021	2'li W. Otomat Kutusu Sıva Üstü	90	33,50
WK.05022	2'li W. Otomat Kutusu Sıva Altı	90	33,50
WK.05041	4'lü W. Otomat Kutusu Sıva Üstü	24	54,00
WK.05042	4'lü W. Otomat Kutusu Sıva Altı	24	54,00
WK.05061	6'li W. Otomat Kutusu Sıva Üstü	36	68,70
WK.05062	6'li W. Otomat Kutusu Sıva Altı	36	68,70
WK.05091	9'lu W. Otomat Kutusu Sıva Üstü	24	91,50
WK.05092	9'lu W. Otomat Kutusu Sıva Altı	24	91,50
WK.05121	12'li W. Otomat Kutusu Sıva Üstü	16	110,80
WK.05122	12'li W. Otomat Kutusu Sıva Altı	16	110,80
WK.05161	16'li W. Otomat Kutusu Sıva Üstü	10	138,00
WK.05162	16'li W. Otomat Kutusu Sıva Altı	10	138,00
WK.05181	18'li W. Otomat Kutusu Sıva Üstü	10	147,50
WK.05182	18'li W. Otomat Kutusu Sıva Altı	10	147,50
WK.05241	24'lü W. Otomat Kutusu Sıva Üstü	10	191,00
WK.05242	24'lü W. Otomat Kutusu Sıva Altı	10	191,00
WK.05361	36'li W. Otomat Kutusu Sıva Üstü	10	239,50
WK.05362	36'li W. Otomat Kutusu Sıva Altı	10	239,50



WK.05021



WK.05062



WK.05091



WK.05122



WK.05161



WK.05362

Dekoratif W. Otomat Kutuları - KLEMENSLİ

EKO

KOD	cinsi	KOLİ	FİYAT
WK.0508	6'lı W. Otomat Kutusu S.Ü.	24	60,50
WK.0521	6'lı W. Otomat Kutusu S.A.	24	60,50
WK.0509	9'lu W. Otomat Kutusu S.Ü.	30	83,00
WK.0510	9'lu W. Otomat Kutusu S.A.	30	83,00
WK.0511	12'li W. Otomat Kutusu S.Ü.	24	96,00
WK.0512	12'li W. Otomat Kutusu S.A.	24	96,00
WK.0526	14'lü W. Otomat Kutusu S.Ü.	10	113,00
WK.0527	14'lü W. Otomat Kutusu S.A.	10	113,00
WK.0513	16'lı W. Otomat Kutusu S.Ü.	20	128,00
WK.0514	16'lı W. Otomat Kutusu S.A.	20	128,00
WK.0515	24'lü W. Otomat Kutusu S.Ü.	10	163,50
WK.0516	24'lü W. Otomat Kutusu S.A.	10	163,50
WK.0547	24'lü W. Otomat Kutusu S.A. Düz Kapak	10	160,00
WK.0522	36'lı W. Otomat Kutusu S.Ü.	10	223,00
WK.0523	36'lı W. Otomat Kutusu S.A.	10	223,00
WK.0556	45'li W. Otomat Kutusu (IP 54)	5	512,00



WK.0508



WK.0510



WK.0515



WK.0523

Lüks W. Otomat Kutuları

KOD	cinsi	KUTU	KOLİ	FİYAT
WK.0544	1'li Lüks W. Otomat Kutusu	20	300	8,60
WK.0598	1-2'li Lüks W. Otomat Kutusu	10	150	9,80
WK.0599	3-4'lü Lüks W. Otomat Kutusu	10	150	13,00
WK.0506	4-8'li Lüks W. Otomat Kutusu	5	60	15,00
WK.0519	1-2'li W. Otomat Kutusu Müh. ABS	10	150	12,90
WK.0520	3-4'lü W. Otomat Kutusu Müh. ABS	10	150	15,70
WK.0500	2-5'li W. Otomat Kutusu S.Ü.	1	60	49,00
WK.0507	W.Otomat Örtme Parçası	100	-	5,80



WK.0544



WK.0598



WK.0519



WK.0500



WK.0507

Nemli Yer W. Otomat Kutuları - KLEMENSLİ

KOD	cinsi	KOLİ	FİYAT
WK.0570	5'li W.Otomat Kutusu (IP 54)	30	98,00
WK.0580	9'lu W.Otomat Kutusu (IP 54)	12	120,00
WK.0590	12'li W.Otomat Kutusu (IP 54)	10	158,00
WK.0556	45'li W.Otomat Kutusu (IP 54)	5	512,00



WK.0556



WK.0580



32 W.Otomat Kapasiteli + Zayıf Akım Kutusu



WKZH.032

- * 1,2 mm Sac Tabanlı ,
- * H.Free Plastik Gövdeli

Ölçü : 405 x 570 x 120 mm
Kutu Adedi : 1
Koli Adedi : 2

Fiyat : 720.00 TL



48 W.Otomat Kapasiteli + Zayıf Akım Kutusu



WKZH.048

- * 1,2 mm Sac Tabanlı ,
- * H.Free Plastik Gövdeli

Ölçü : 405 x 900 x 125 mm
Kutu Adedi : 1
Koli Adedi : 2

Fiyat : 1.020,00 TL



WKZH.032-1

- * 1,2 mm Sac Tabanlı ,
- * H.Free Plastik Gövdeli

Ölçü : 405 x 570 x 120 mm
Kutu Adedi : 1
Koli Adedi : 2

Fiyat : 748.00 TL



WKZH.048-1

- * 1,2 mm Sac Tabanlı ,
- * H.Free Plastik Gövdeli

Ölçü : 405 x 900 x 125 mm
Kutu Adedi : 1
Koli Adedi : 2

Fiyat : 1.046,00 TL



Sac W. Otomat Kutusu -KLEMENSLİ



KOD	cinsi	KOLİ	FİYAT
WK.0548	24'lü Sac W. Otomat Kutusu Sıva Altı H.F	10	205,00
WK.0549	36'lı Sac W. Otomat Kutusu Sıva Altı H.F	10	280,00
WK.0550	48'li Sac W. Otomat Kutusu Sıva Altı H.F	3	720,00
WK.0551	80'li Sac W. Otomat Kutusu Sıva Altı H.F	2	1.020,00
WK.0552	48'li Sac W. Otomat Kutusu Sıva Üstü H.F	3	748,00
WK.0553	80'li Sac W. Otomat Kutusu Sıva Üstü H.F	2	1.046,00

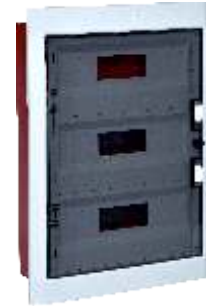

WK.0550



WK.0548



PM.0854

Mon. Say. Kut. 5 Sig. Kap.
185x365x100 mm
Koli Adedi: 15
256,00 TL



PM.0855

Mon. Mod. Say. Kut. 9 Sig. Kap.
215x405x115 mm
Koli Adedi: 10
288,00 TL



PM.0857

Mon. İkili Say. Kut. 15 Sig. Kap.
540x350x130 mm
Koli Adedi: 5
420,00 TL



PM.0856

Tri. Say. Kut. 15 Sig. Kap.
540x350x130 mm
Koli Adedi: 5
420,00 TL



PM.0855-2

Sac S.A. Mon. Mod. Say. Kut.
9 Sig. Kap. 215x405x115 mm
Koli Adedi: 10
311,50 TL



Şeffaf

PM.0854-1

Mon. Say. Kut. 5 Sig. Kap.
185x365x100 mm
Koli Adedi: 15
273,00 TL



Şeffaf

PM.0855-1

Mon. Mod. Say. Kut. 9 Sig. Kap.
215x405x115 mm
Koli Adedi: 10
310,00 TL



Şeffaf

PM.0857-1

Mon İkili Say Kut 15 Sig. Kap.
540x350x130 mm
Koli Adedi: 5
448,00 TL



Şeffaf

PM.0856-1

Tri Say. Kut. 15 Sig. Kap.
540x350x130 mm
Koli Adedi: 5
448,00 TL



PM.0857-2

Sac S.A. Mon İkili Say Kut
15 Sig. Kap. 540x350x130 mm
Koli Adedi: 5
448,00 TL



WK.0556

45'li Nemli Yer W. Oto. Kut.
540x350x130 mm
Koli Adedi: 5
506,00 TL



TK.0456

30'lu Harici Modül Kut.
540x350x130 mm
Koli Adedi: 5
568,00 TL



P05315

Taban Saçlı Pano (IP65)
540x350x130 mm
Koli Adedi: 5
460,00 TL



PM.0856 PM.0857
WK.0556 P05315

Bu Kodlu ürünler için uygundur.



KB.0028

Modüler Priz Buatı
350x110x95 mm
Kutu Adedi: 4
86,00 TL



PM.0856-2

Sac S.A. Tri Say. Kut.
15 Sig. Kap. 540x350x130 mm
Koli Adedi: 5
448,00 TL



PM.0841

Lüks Tri. Dij. Mek. Say. Kut.
Koli Adedi: 10
169,50 TL



PM.0843

Lüks Mon. Dij. Say. Kut.
Koli Adedi: 24
127,50 TL



PM.0845

Lüks Mek. Dij. Say. Kut. S.A
Koli Adedi: 18
131,00 TL



PM.0850

İst. Tipi Say. Kut. Pak. Ad. : 10
Çuv. Ad.: 100
50,00 TL



Metal Kablo Bağları

KOD	EN	BOY	POŞET MİKTARI	KOLİ MİKTARI	MAKS. SIKMA ÇAPI (mm)	AÇILMA MUK. (kg)	FİYAT
CBM.14615		150	100	8.000	44		2,52
CBM.14620		200	100	6.000	51		2,85
CBM.14626		260	100	5.000	69		3,13
CBM.14630	4.6	300	100	5.000	76	55	3,34
CBM.14637		370	100	4.000	102		3,68
CBM.14652		520	100	3.000	152		4,75
CBM.14668		680	100	2.000	203		5,66
CBM.14684		840	100	1.000	254		6,87
CBM.17920		200	100	5.000	50		4,04
CBM.17930		300	100	4.000	75		4,55
CBM.17937	7.9	370	100	3.000	102	120	5,14
CBM.17952		520	100	2.000	152		6,77
CBM.17968		680	100	2.000	203		8,61
CBM.17984		840	100	1.000	224		9,45

ULTRAVIOLE Kablo Bağları

CBUV.12510		100	1000	70.000	20		0,136
CBUV.12515	2.5	150	1000	55.000	36	8	0,210
CBUV.12520		200	1000	32.000	52		0,300
CBUV.13615		150	100	30.000	36		0,346
CBUV.13620		200	100	20.000	52		0,446
CBUV.13625	3.6	250	100	20.000	68	18	0,546
CBUV.13630		300	100	17.000	84		0,667
CBUV.14820		200	100	16.000	50		0,640
CBUV.14825		250	100	12.000	65		0,777
CBUV.14830	4.8	300	100	11.000	81	22	0,945
CBUV.14837		370	100	9000	104		1,113
CBUV.14843		430	100	7.500	123		1,433
CBUV.17630		300	100	5.000	76		1,869
CBUV.17637	7.6	370	100	4.000	102	55	2,021
CBUV.17643		430	100	2.500	110		2,373
CBUV.17653		530	100	2.000	140		3,130
CBUV.19078	9.0	780	100	2.000	228	80	6,772

ULTRAVIOLE

Kablo Bağları - RENKLİ (SARI-MAVİ-KIRMIZI-YEŞİL-GRİ)

CBR.12510	2.5	100	250	40.000	26	8	Fiyat Sorunuz
CBR.13615		150	100	10.000	35		Fiyat Sorunuz
CBR.13620		200	100	10.000	50		Fiyat Sorunuz
CBR.13625	3.6	250	100	10.000	65	18	Fiyat Sorunuz
CBR.13630		300	100	10.000	80		Fiyat Sorunuz
CBR.13637		370	100	10.000	100		Fiyat Sorunuz
CBR.14820		200	100	10.000	50		Fiyat Sorunuz
CBR.14825		250	100	10.000	65		Fiyat Sorunuz
CBR.14830	4.8	300	100	10.000	80	25	Fiyat Sorunuz
CBR.14838		380	100	5.000	100		Fiyat Sorunuz
CBR.14840		400	100	5.000	102		Fiyat Sorunuz



BEYAZ KABLO BAĞLARI

KOD	EN	BOY	POŞETMİKTARI	KOLİ MİKTARI	MAKS. SIKMA ÇAPI (mm)	AÇILMA MUK. (kg)	FİYAT
CB.02510		100	250	40.000	26		0,080
CB.02515	2.5	150	100	20.000	35	8	0,136
CB.02520		200	100	15.000	50		0,192
CB.03615		150	100	10.000	35		0,232
CB.03620		200	100	10.000	50		0,304
CB.03625	3.6	250	100	10.000	65	18	0,356
CB.03630		300	100	10.000	80		0,470
CB.03637		370	100	10.000	100		0,586
CB.04820		200	100	10.000	50		0,370
CB.04825		250	100	10.000	65		0,480
CB.04830	4.8	300	100	10.000	80	25	0,588
CB.04838		380	100	5.000	100		0,820
CB.04840		400	100	5.000	102		0,836
CB.07630		300	100	3.000	85		1,174
CB.07638	7.6	380	100	2.500	102	55	1,492
CB.07645		450	100	3.000	135		1,676
CB.07655		550	100	2.500	165		2,210
CB.09075		750	100	1.000	235		3,820
CB.09095	9.0	950	100	1.000	280	80	4,960

SİYAH KABLO BAĞLARI

CB.02510-1		100	250	40.000	26		0,080
CB.02515-1	2.5	150	100	20.000	35	8	0,136
CB.02520-1		200	100	15.000	50		0,192
CB.03615-1		150	100	10.000	35		0,232
CB.03620-1		200	100	10.000	50		0,304
CB.03625-1	3.6	250	100	10.000	65	18	0,356
CB.03630-1		300	100	10.000	80		0,470
CB.03637-1		370	100	10.000	100		0,586
CB.04820-1		200	100	10.000	50		0,370
CB.04825-1		250	100	10.000	65		0,480
CB.04830-1	4.8	300	100	10.000	80	25	0,588
CB.04838-1		380	100	5.000	100		0,820
CB.04840-1		400	100	5.000	102		0,836
CB.07630-1		300	100	3.000	85		1,174
CB.07638-1	7.6	380	100	2.500	102	55	1,492
CB.07645-1		450	100	3.000	135		1,676
CB.07655-1		550	100	2.500	165		2,210
CB.09075-1		750	100	1.000	235		3,820
CB.09095-1	9.0	950	100	1.000	280	80	4,960

8mm. Dübelli Kablo Bağlar

DB.0145		150	100	4.000	35		0,690
DB.0144	9.0	200	100	3.000	55	55	0,750

Etiketli Kablo Bağları

CBE.12510	2.5	100	100	30.000	18	8	0,360
CBE.14819	4.8	190	100	15.000	45	22	0,960

Yapışkan Kroşeler

KOD	CİNSİ	PAKET	KOLİ	FİYAT
CB.01919	Yapışkan Kroşe 19 x 19	100	10.000	0,430
CB.02828	Yapışkan Kroşe 28 x 28	100	4.000	0,595



CB.01919



CB.02828

Vidalı Kroşeler

KOD	CİNSİ	PAKET	KOLİ	FİYAT
CB.01017	Vidalı Kroşe 10 x 17	250	25.000	0,266
CB.01530	Vidalı Kroşe 15 x 30	100	10.000	0,300
CB.01723	Vidalı Kroşe 17 x 23	100	8.000	0,270



CB.01017



CB.01530

Kablo Bağı Dübeli ve Kroşesi

KOD	CİNSİ	PAKET	KOLİ	FİYAT
DB.02128	Delikli Duvar Kroşe 7 mm.	100	10.000	0,256
DB.0155	Kablo Bağı Dübeli 8 mm. (Lok Kroşe)	100	5.000	0,390
DB.0156	Kablo Bağı Dübeli 10 mm. (Lok Kroşe)	100	5.000	0,412



DB.02128



DB.0155

Kablo Bağı Etiket Taşıyıcı

KOD	CİNSİ	PAKET	KOLİ	FİYAT
DB.2170	10 x 35 Etiket Taşıyıcı	100	8.000	1,000
DB.2171	20 x 45 Etiket Taşıyıcı	100	8.000	1,750



DB.2170

Tekli & Çiftli Kroşeler

KOD	CİNSİ	PAKET	KOLİ	FİYAT
DB.02144	Tekli Kroşe 8 x 18	500	5.000	0,310
DB.02150	Çiftli Kroşe 20 mm	100	4.000	0,404
DB.02151	Çiftli Kroşe 25 mm	100	3.000	0,422



DB.02144



DB.02151

Dübeller

KOD	CİNSİ	PAKET	KOLİ	FİYAT
DB.0150	Pls. Dübél 6 mm.	1000	30.000	0,062
DB.0160	Pls. Dübél 7 mm. Köşeli	1000	20.000	0,068
DB.0161	Pls. Dübél 8 mm. Köşeli	1000	20.000	0,088
DB.0162	Pls. Dübél 10 mm.	500	10.000	0,240
DB.0154	Pls. Dübél 12 mm.	300	5.000	0,364
DB.0146	Çivili Kanal Dübeli	500	10.000	0,230
DB.0148	Çivili Kanal Dübeli - Korniş Dübél	100	5.000	0,236
DB.02142	Del-Çak Dübél 8 mm.	500	80.000	0,264
DB.0147	Alçıpan Dübél	250	5.000	0,286
DB.0149	Burgu Alçıpan Dübél	250	5.000	0,262
DB.0157	Roket(Performans) Dübeli 8 mm.	1000	-	0,266
DB.0158	Roket(Performans) Dübeli 10 mm.	500	-	0,460
DB.1162	Ytong(Gaz Beton) Dübeli 8mm.	100	25.000	1,340
DB.1163	Ytong(Gaz Beton) Dübeli 10mm.	100	25.000	1,400
DB.1164	Tuğla Boşluk Dübeli 8mm.	500	25.000	0,370



DB.0147



DB.0149



DB.0150



DB.0146



DB.0157



DB.02142

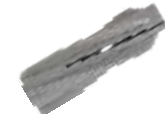

DB.1162



DB.1164

Pano Etiketleri

KOD	CİNSİ	PAKET	KOLİ	FİYAT
DB.2160	Yapışkanlı Pano Etiketi 30 x 14	100	-	2,400
DB.2161	Yapışkanlı Pano Etiketi 52 x 14	100	-	3,350
DB.2162	Yapışkanlı Sinyal Pano Etiketi	100	-	5,400



DB.2161



DB.2162

Sunta Vidaları

KOD	CİNSİ	ADET	KOLİ	FİYAT
SV.4030	4 x 30 Sunta Vidası (1 Ad. Fiyatı)	500	10.000	0,273
SV.4035	4 x 35 Sunta Vidası (1 Ad. Fiyatı)	500	10.000	0,308
SV.4040	4 x 40 Sunta Vidası (1 Ad. Fiyatı)	500	8.000	0,345
SV.4045	4 x 45 Sunta Vidası (1 Ad. Fiyatı)	500	8.000	0,400
SV.4050	4 x 50 Sunta Vidası (1 Ad. Fiyatı)	500	7.200	0,480
SV.4530	4,5 x 30 Sunta Vidası (1 Ad. Fiyatı)	500	10.000	0,375
SV.4535	4,5 x 35 Sunta Vidası (1 Ad. Fiyatı)	200	4.000	0,430
SV.4540	4,5 x 40 Sunta Vidası (1 Ad. Fiyatı)	200	4.000	0,455
SV.4545	4,5 x 45 Sunta Vidası (1 Ad. Fiyatı)	200	4.000	0,510
SV.4550	4,5 x 50 Sunta Vidası (1 Ad. Fiyatı)	200	4.000	0,545
SV.4560	4,5 x 60 Sunta Vidası (1 Ad. Fiyatı)	200	3.200	0,625
SV.5030	5 x 30 Sunta Vidası (1 Ad. Fiyatı)	200	4.000	0,455
SV.5035	5 x 35 Sunta Vidası (1 Ad. Fiyatı)	200	4.000	0,495
SV.5040	5 x 40 Sunta Vidası (1 Ad. Fiyatı)	200	4.000	0,560
SV.5045	5 x 45 Sunta Vidası (1 Ad. Fiyatı)	200	4.000	0,620
SV.5050	5 x 50 Sunta Vidası (1 Ad. Fiyatı)	200	4.000	0,660
SV.5060	5 x 60 Sunta Vidası (1 Ad. Fiyatı)	200	3.200	0,785



Piton (Kanca) Vidaları

KOD	CİNSİ	ADET	FİYAT
AV.1970	19 x 70 Kanca Vidası (1 Ad. Fiyatı)	100	0,930
AV.2080	20 x 80 Kanca Vidası (1 Ad. Fiyatı)	100	1,230
AV.2180	21 x 80 Kanca Vidası (1 Ad. Fiyatı)	100	1,350
AV.2110	21 x 100 Kanca Vidası (1 Ad. Fiyatı)	100	1,500
AV.7005	M5 Tavan Askısı (85 mm.) (1 Ad. Fiyatı)	50	1,650



AV.7005



AV.2180

Yıldız Başlı Ağaç Vidaları

KOD	CİNSİ	GROSA	FİYAT
AV.2020	20 x 20 Ağaç Vidası (Grosa Fiyatı)	12	24,70
AV.2025	20 x 25 Ağaç Vidası (Grosa Fiyatı)	12	26,00

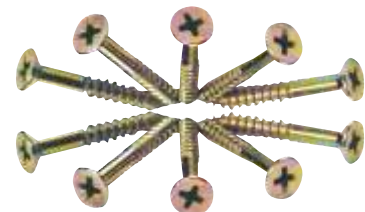

**CA.10200**

45 x 45 Topraklı Priz
Kutu Adedi: 50
20,45 TL

**CA.10200-2**

45 x 45 Topraklı Priz 2'li
Kutu Adedi: 54
46,46 TL

**CA.10200-3**

45 x 45 Topraklı Priz 3'lü
Kutu Adedi: 36
59,75 TL

**CA.10200-4**

45 x 45 Topraklı Priz 4'lü
Kutu Adedi: 24
73,90 TL

**CA.10203**

45 x 45 Topraklı UPS Priz
Kutu Adedi: 50
22,15 TL

**CA.10203-2**

45 x 45 Ups Priz 2'li
Kutu Adedi: 54
53,55 TL

**CA.10203-3**

45 x 45 Ups Priz 3'lü
Kutu Adedi: 36
63,30 TL

**CA.10203-4**

45 x 45 Ups Priz 4'lü
Kutu Adedi: 24
77,90 TL

**CA.10206**

45 x 22.5 Faceplate Tekli
Kutu Adedi: 100
8,80 TL

**CA.10207**

45 x 45 Faceplate Tekli
Kutu Adedi: 100
13,35 TL

**CA.10208**

45 x 45 Faceplate Çiftli
Kutu Adedi: 100
22,50 TL

**CA.10209**

45 x 22.5 Kör Tapa
Kutu Adedi: 100
5,50 TL

**CA.10220**

45x45 mm Üniversal Priz
Kutu Adedi: 24
122,00 TL

**CA.10210**

CAT3 RJ 11 - 12
Keystone Jack
Kutu Adedi: 200
15,40 TL

**CA.10211**

CAT5e RJ 45 Keystone Jack
Kutu Adedi: 100
15,60 TL

**CA.10212**

CAT6 RJ 45 Keystone Jack
Kutu Adedi: 100
17,00 TL

**CA.10218**

CAT6A RJ 45
Keystone Jack 10GB
Kutu Adedi: 100
62,50 TL

**CA.10221**

45x45 mm Anahtar (Vidalı)
Kutu Adedi: 50
37,20 TL

**CA.10216**

45 x 22.5 USB Priz
Kutu Adedi: 100
134,75 TL

**CA.10219**

45 x 22.5 İkilili USB Şarj Adaptörü
Kutu Adedi: 30
203,80 TL

**CA.10217**

45 x 22.5 HDMI Priz
Kutu Adedi: 100
102,50 TL

**CA.10222**

45x22,5 mm VGA Dişi Giriş Çıkışı
Kutu Adedi: 50
99,80 TL

**CA.10223**

45x45 mm
Stereo Jack (3,5mm)
Kutu Adedi: 50
46,35 TL

**CA.10224**

45x22,5 mm Anahtar
Kutu Adedi: 50
30,30 TL

**CA.10225**

45x45 mm Anahtar
Kutu Adedi: 50
32,10 TL

**CA.10226**

45x22,5 mm Uydu Prizi
Kutu Adedi: 50
17,30 TL

**CA.10227**

45x45 mm Uydu Prizi
Kutu Adedi: 50
18,20 TL

ÇET-SAN 1. Kalite Yapışkanlı Kablo Kanalları

KOD	CİNSİ	METRE	FİYAT
ÇET.1212-1	12x12 Yapışkanlı Kablo Kanalı	280	5,80
ÇET.1612-1	16x12 Yapışkanlı Kablo Kanalı	240	6,10
ÇET.1616-1	16x16 Yapışkanlı Kablo Kanalı	280	7,30
ÇET.2010-1	20x10 Yapışkanlı Kablo Kanalı	240	7,80
ÇET.2516-1	25x16 Yapışkanlı Kablo Kanalı	160	11,70
ÇET.2525-1	25x25 Yapışkanlı Kablo Kanalı	100	16,00
ÇET.4016-1	40x16 Yapışkanlı Kablo Kanalı	120	19,90
ÇET.4025-1	40x25 Yapışkanlı Kablo Kanalı	80	23,80
ÇET.4040-1	40x40 Yapışkanlı Kablo Kanalı	50	27,50

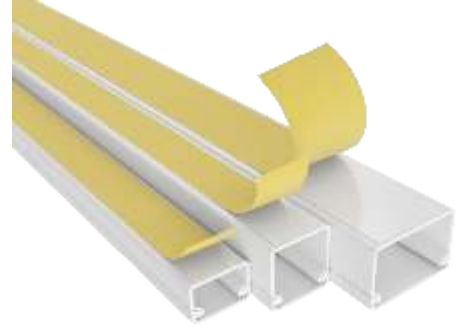

Yapışkanlı Kablo Kanalları EKO

KOD	CİNSİ	METRE	FİYAT
EVL.1212-1	12x12 Yapışkanlı Kablo Kanalı	320	5,00
EVL.1616-1	16x16 Yapışkanlı Kablo Kanalı	250	6,70
EVL.2010-1	20x10 Yapışkanlı Kablo Kanalı	240	7,00
EVL.2516-1	25x16 Yapışkanlı Kablo Kanalı	154	10,70
EVL.2525-1	25x25 Yapışkanlı Kablo Kanalı	96	14,00
EVL.4016-1	40x16 Yapışkanlı Kablo Kanalı	84	17,50
EVL.4025-1	40x25 Yapışkanlı Kablo Kanalı	80	20,20
EVL.4040-1	40x40 Yapışkanlı Kablo Kanalı	72	24,40
EVL.6040-1	60x40 Yapışkanlı Kablo Kanalı	48	36,00

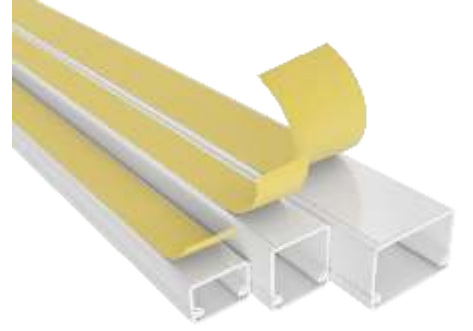

Kablo Kanalları EKO

KOD	CİNSİ	METRE	FİYAT
EVL.1212	12x12 Kablo Kanalı	320	4,40
EVL.1616	16x16 Kablo Kanalı	266	6,20
EVL.2010	20x10 Kablo Kanalı	240	6,36
EVL.2516	25x16 Kablo Kanalı	154	9,50
EVL.2525	25x25 Kablo Kanalı	96	12,50
EVL.4016	40x16 Kablo Kanalı	84	15,00
EVL.4025	40x25 Kablo Kanalı	80	17,60
EVL.4040	40x40 Kablo Kanalı	72	21,50
EVL.6040	60x40 Kablo Kanalı	48	32,00
EVL.6060	60x60 Ara Bölmeli Kablo Kanalı	40	43,50
EVL.8050	80x50 Kablo Kanalı	32	56,00
EVL.1040	100x40 Kablo Kanalı	28	57,00
EVL.1060	100x60 Kablo Kanalı	24	82,50



Renkli Yapışkanlı Kablo Kanalları

KOD	CİNSİ	METRE	FİYAT
ÇETR.1212-1	12x12 Renkli Yapışkanlı Kablo Kanalı	280	23,70
ÇETR.1612-1	16x12 Renkli Yapışkanlı Kablo Kanalı	240	26,00
ÇETR.1616-1	16x16 Renkli Yapışkanlı Kablo Kanalı	280	28,75
ÇETR.2010-1	20x10 Renkli Yapışkanlı Kablo Kanalı	240	27,20
ÇETR.2516-1	25x16 Renkli Yapışkanlı Kablo Kanalı	160	37,00
ÇETR.2525-1	25x25 Renkli Yapışkanlı Kablo Kanalı	100	51,70
ÇETR.4016-1	40x16 Renkli Yapışkanlı Kablo Kanalı	120	72,40
ÇETR.4025-1	40x25 Renkli Yapışkanlı Kablo Kanalı	80	69,60
ÇETR.4040-1	40x40 Renkli Yapışkanlı Kablo Kanalı	50	80,00



A. AĞAÇ



KAYIN



GÖLE CEVİZ



KIRAZ

Renkli Kablo Kanalları

KOD	CİNSİ	METRE	FİYAT
ÇETR.1212	12x12 Renkli Kablo Kanalı	280	21,65
ÇETR.1612	16x12 Renkli Kablo Kanalı	240	22,10
ÇETR.1616	16x16 Renkli Kablo Kanalı	280	27,20
ÇETR.2010	20x10 Renkli Kablo Kanalı	240	23,90
ÇETR.2516	25x16 Renkli Kablo Kanalı	160	34,35
ÇETR.2525	25x25 Renkli Kablo Kanalı	100	47,40
ÇETR.4016	40x16 Renkli Kablo Kanalı	120	47,85
ÇETR.4025	40x25 Renkli Kablo Kanalı	80	58,80
ÇETR.4040	40x40 Renkli Kablo Kanalı	50	73,50



A. AĞAÇ



KAYIN



GÖLE CEVİZ



KIRAZ

Balıksırtı Renkli Kablo Kanalları

KOD	CİNSİ	METRE	FİYAT
ÇETR.5012	50x12 Balık Sırtı Kablo Kanalı	80	63,00



50x12

Akça ağaç, Kiraz, Kayın, Ceviz

Delikli Kablo Kanalları -GRİ

KOD	CİNSİ	METRE	FİYAT
ÇETD.2525	25x25 Delikli Kablo Kanalı Gri	100	24,50
ÇETD.2540	25x40 Delikli Kablo Kanalı Gri	80	30,50
ÇETD.2560	25x60 Delikli Kablo Kanalı Gri	36	47,00
ÇETD.4040	40x40 Delikli Kablo Kanalı Gri	50	40,20
ÇETD.4060	40x60 Delikli Kablo Kanalı Gri	40	53,40
ÇETD.4080	40x80 Delikli Kablo Kanalı Gri	32	80,00
ÇETD.6040	60x40 Delikli Kablo Kanalı Gri	40	58,00
ÇETD.6060	60x60 Delikli Kablo Kanalı Gri	36	67,25
ÇETD.6080	60x80 Delikli Kablo Kanalı Gri	24	84,80
ÇETD.1060	100x60 Delikli Kablo Kanalı Gri	18	112,00

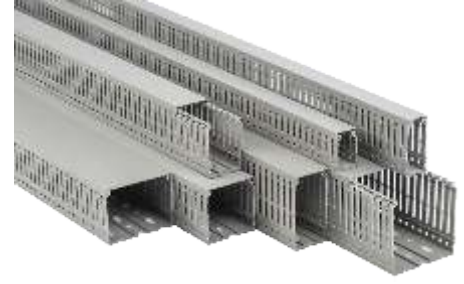

Balıksırtı Kablo Kanalları

KOD	CİNSİ	METRE	FİYAT
ÇET.5012	50x12 Balıksırtı Kablo Kanalı	80	36,80
ÇET.9019	90x19 Balıksırtı Kablo Kanalı	40	99,50



90x19



50x12

100x38-100x52 İçten Kapaklı Kablo Kanal ve Aksesuarları

KOD	CİNSİ	KUTU	METRE	FİYAT
ÇET.1038	100x38 İçten Kapaklı Kablo Kanalı 2 mm	-	30	85,00
ÇET.1052	100x52 İçten Kapaklı Kablo Kanalı 2 mm	-	20	94,50
CA.10180	Ara Bölme	-	150	26,25
CA.10181	Tekli Çerçeve	20	-	17,45
CA.10182	İkili Çerçeve	20	-	22,80
CA.10183	Üçlü Çerçeve	20	-	27,30
CA.10175	T Profil	5	-	26,25
CA.10174	İç Köşe	5	-	26,25
CA.10173	Dış Köşe	5	-	26,25
CA.10178	Uç Tapa - Sonlama	20	-	14,10
CA.10177	Ek Yeri Kapama - Birleştirme	25	-	12,20
CA.10176	90 L Köşe Profil	4	-	26,25
CA.10179	Kablo Tutucu	50	-	16,50



CA.10181

CA.10182

CA.10183



CA.10173



CA.10174



CA.10175



CA.10176



CA.10177



CA.10178

Polikarbonat Panolar**IP54 SAC TABANLI**

KOD	cinsi	KUTU	KOLİ	FİYAT
P03210	20 x 30 x 10 Polikarbonat Pano	1	12	191,00
P03215	20 x 30 x 15 Polikarbonat Pano	1	12	203,00
P03220	20 x 30 x 20 Polikarbonat Pano	1	9	214,00

**Polikarbonat Panolar****IP54 SAC TABANLI**

KOD	cinsi	KUTU	KOLİ	FİYAT
P04312	30 x 40 x 12 Polikarbonat Pano	1	6	292,00
P04316	30 x 40 x 16 Polikarbonat Pano	1	6	310,00
P04320	30 x 40 x 20 Polikarbonat Pano	1	4	328,00

**Polikarbonat Panolar****IP54 SAC TABANLI**

KOD	cinsi	KUTU	KOLİ	FİYAT
P06420	40 x 60 x 20 Polikarbonat Pano	1	3	590,00

**Polikarbonat Panolar****IP54 SAC TABANLI**

KOD	cinsi	KUTU	KOLİ	FİYAT
P07520	50 x 70 x 20 Polikarbonat Pano	1	2	948,00

**Polikarbonat Panolar Şeffaf Kapaklı****IP54 SAC TABANLI**

KOD	cinsi	KUTU	KOLİ	FİYAT
P03210-3	20 x 30 x 10 Polikarbonat Pano Şeffaf	1	12	234,00
P03215-3	20 x 30 x 15 Polikarbonat Pano Şeffaf	1	12	246,00
P03220-3	20 x 30 x 20 Polikarbonat Pano Şeffaf	1	9	258,00
P04312-3	30 x 40 x 12 Polikarbonat Pano Şeffaf	1	6	360,00
P04316-3	30 x 40 x 16 Polikarbonat Pano Şeffaf	1	6	376,00
P04320-3	30 x 40 x 20 Polikarbonat Pano Şeffaf	1	4	398,00
P06420-3	40 x 60 x 20 Polikarbonat Pano Şeffaf	1	3	660,00
P07520-3	50 x 70 x 20 Polikarbonat Pano Şeffaf	1	2	1.097,00



ABS Panolar Opak Kapaklı

SAC TABANLI

KOD	cinsi	KUTU	KOLİ	FİYAT
P02231	22 x 31 x 14 ABS Pano	1	12	218,00
P02735	27 x 35 x 16 ABS Pano	1	8	300,00
P03242	32 x 42 x 18 ABS Pano	1	6	390,00
P03550	35 x 50 x 20 ABS Pano	1	4	560,00
P04252	42 x 52 x 19 ABS Pano	1	4	586,00
P04060	40 x 60 x 20 ABS Pano	1	3	692,00
P04366	43 x 66 x 21 ABS Pano	1	3	746,00
P05060	50 x 60 x 22 ABS Pano	1	3	942,00
P05070	50 x 70 x 25 ABS Pano	1	2	1.047,00
P06080	60 x 80 x 26 ABS Pano	1	2	1.576,00



ABS Panolar Şeffaf Kapaklı

SAC TABANLI

KOD	cinsi	KUTU	KOLİ	FİYAT
PŞ.02231	22 x 31 x 14 ABS Pano Şeffaf	1	12	274,00
PŞ.02735	27 x 35 x 16 ABS Pano Şeffaf	1	8	366,00
PŞ.03242	32 x 42 x 18 ABS Pano Şeffaf	1	6	475,00
PŞ.03550	35 x 50 x 20 ABS Pano Şeffaf	1	4	690,00
PŞ.04252	42 x 52 x 19 ABS Pano Şeffaf	1	4	712,00
PŞ.04060	40 x 60 x 20 ABS Pano Şeffaf	1	3	820,00
PŞ.04366	43 x 66 x 21 ABS Pano Şeffaf	1	3	876,00
PŞ.05060	50 x 60 x 22 ABS Pano Şeffaf	1	3	1.060,00
PŞ.05070	50 x 70 x 25 ABS Pano Şeffaf	1	2	1.188,00
PŞ.06080	60 x 80 x 26 ABS Pano Şeffaf	1	2	1.790,00



ABS & Şeffaf Kapaklı Otomat Panoları

SAC TABANLI

KOD	cinsi	KUTU	KOLİ	FİYAT
PAW.03550	35 x 50 x 20 ABS Otomat Panosu	12 x 3	1	760,00
PAW.04060	40 x 60 x 20 ABS Otomat Panosu	15 x 4	1	920,00
PŞW.03551	35 x 50 x 20 Şeffaf Otomat Panosu	12 x 3	1	860,00
PŞW.04061	40 x 60 x 20 Şeffaf Otomat Panosu	15 x 4	1	964,00



TMŞ Kompakt Şalter Panoları

SAC TABANLI

KOD	cinsi	KUTU	KOLİ	FİYAT
ŞP02735	27 x 35 x 16 Şalter Panosu (50A-160A)	1	8	436,00
ŞP03242	32 x 42 x 18 Şalter Panosu (200A-250A)	1	6	540,00



20x20x20 Menholler & Rögar Kapakları

KOD	CİNSİ	KOLİ	FİYAT
LG.20200	20x20x20 Menhol Düz Kapaklı	20	67,00
LG.20201	Menhol Kapaksız	20	59,00
LG.20202	Düz Kapak	1	23,50
LG.20203	Izgara Kapak	1	21,80
LG.20204	Düz Yeşil Kapak	1	27,50
LG.20205	Izgara Yeşil Kapak	1	26,60
LG.20207	Çerçeve	1	21,70

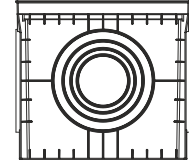

30x30x30 Menholler & Rögar Kapakları

KOD	CİNSİ	KOLİ	FİYAT
LG.30300	30x30x30 Menhol Düz Kapaklı 4 Çıkışlı	4	139,70
LG.30301	Menhol Kapaksız	4	98,00
LG.30302	Düz Kapak	1	56,00
LG.30303	Izgara Kapak	1	58,00
LG.30304	Düz Yeşil Kapak	1	70,00
LG.30305	Izgara Yeşil Kapak	1	72,50
LG.30306	Menhol 6 Çıkışlı Kapaklı	4	154,00
LG.30307	Çerçeve	1	32,00

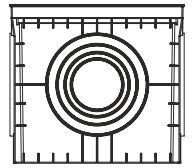
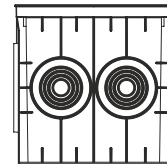

35x35x35 Menholler & Rögar Kapakları

KOD	CİNSİ	KOLİ	FİYAT
LG.35350	35x35x35 Menhol Düz Kapaklı 4 Çıkışlı	4	222,00
LG.35351	Menhol Kapaksız	4	161,00
LG.35352	Düz Kapak	1	104,00
LG.35353	Izgara Kapak	1	114,00
LG.35354	Düz Yeşil Kapak	1	126,00
LG.35355	Izgara Yeşil Kapak	1	125,00
LG.35357	Çerçeve	1	66,00

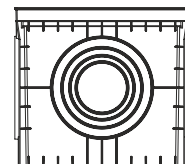
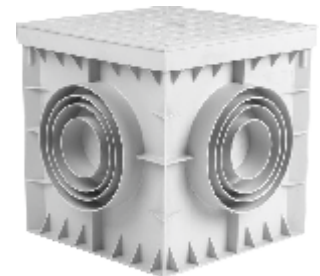

40x40x40 Menholler & Rögär Kapakları

KOD	CİNSİ	KOLİ	FİYAT
LG.40400	40x40x40 Menhol Düz Kapaklı 4 Çıkışlı	2	254,00
LG.40401	Menhol Kapaksız	2	182,00
LG.40402	Düz Kapak	1	78,00
LG.40403	Izgara Kapak	1	81,00
LG.40404	Düz Yeşil Kapak	1	88,00
LG.40405	Izgara Yeşil Kapak	1	88,00
LG.40406	Menhol 6 Çıkışlı Kapaklı	2	289,00
LG.40407	Çerçeve	1	51,00

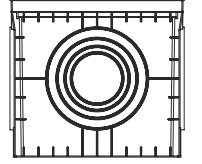
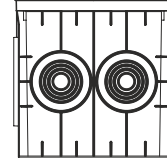
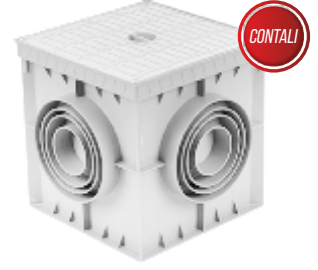
**50x50x50 Menholler & Rögär Kapakları**

KOD	CİNSİ	KOLİ	FİYAT
LG.50500	50x50x50 Menhol Düz Kapaklı 4 Çıkışlı	1	494,00
LG.50501	Menhol Kapaksız	1	338,00
LG.50502	Düz Kapak	1	253,00
LG.50503	Izgara Kapak	1	278,00
LG.50504	Düz Yeşil Kapak	1	306,00
LG.50505	Izgara Yeşil Kapak	1	300,00
LG.50507	Çerçeve	1	82,00

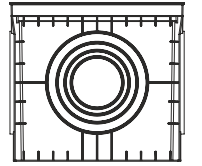
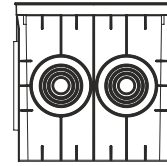
**55x55x55 Menholler & Rögär Kapakları**

KOD	CİNSİ	KOLİ	FİYAT
LG.55550	55x55x55 Menhol Düz Kapaklı 4 Çıkışlı	1	600,00
LG.55551	Menhol Kapaksız	1	420,00
LG.55552	Düz Kapak	1	180,00
LG.55553	Izgara Kapak	1	180,00
LG.55554	Düz Yeşil Kapak	1	220,00
LG.55555	Izgara Yeşil Kapak	1	220,00
LG.55556	Menhol 10 Çıkışlı Kapaklı	1	670,00
LG.55557	Çerçeve	1	90,00

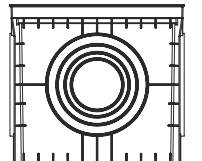
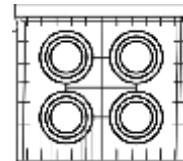
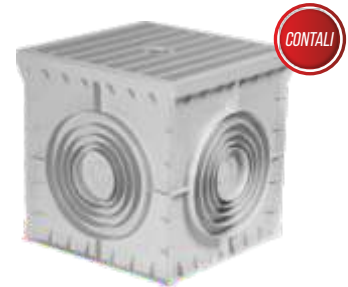

Termoplastik Polikarbonat Buatlar

IP54

KOD	CİNSİ		KUTU	KOLİ	FİYAT
KB.0029	80 x 80 x 45	Termo Pls. Buat	10	240	9,70
KB.0025	85 x 85 x 55	Termo Pls. Buat	10	150	10,20
KB.0017	98 x 98 x 97	Termo Pls. Buat	6	72	23,00
KB.0018	100 x 100 x 60	Termo Pls. Buat	10	100	28,50
KB.0019	120 x 120 x 60	Termo Pls. Buat	10	80	32,80
KB.0021	120 x 120 x 100	Termo Pls. Buat	6	48	35,00
KB.0016	125 x 100 x 75	Termo Pls. Buat	8	80	37,00
KB.0026	125 x 100 x 105	Termo Pls. Buat	6	60	41,70
KB.0020	140 x 140 x 70	Termo Pls. Buat	10	80	39,00
KB.0022	140 x 140 x 100	Termo Pls. Buat	6	48	50,70
KB.0030	140 x 140 x 145	Termo Pls. Buat	2	24	52,30
KB.0015	155 x 115 x 80	Termo Pls. Buat	4	48	52,00
KB.0023	160 x 160 x 75	Termo Pls. Buat	4	48	54,60
KB.0024	180 x 180 x 80	Termo Pls. Buat	4	36	58,80
KB.0014	195 x 145 x 85	Termo Pls. Buat	4	36	66,00
KB.0031	195 x 145 x 145	Termo Pls. Buat	2	9	69,00
KB.0013	210 x 110 x 90	Termo Pls. Buat	2	40	66,00
KB.0027	210 x 110 x 125	Termo Pls. Buat	4	32	75,50
KB.0012	250 x 195 x 96	Termo Pls. Buat	2	24	76,40
KB.0032	250 x 195 x 145	Termo Pls. Buat	1	9	81,70
KB.0009	300 x 200 x 93	Termo Pls. Buat	2	18	89,00
KB.0011	300 x 200 x 125	Termo Pls. Buat	1	15	101,00
KB.0033	300 x 200 x 145	Termo Pls. Buat	1	9	104,80
KB.0008	350 x 255 x 93	Termo Pls. Buat	2	12	104,80
KB.0010	350 x 255 x 125	Termo Pls. Buat	1	10	110,00
KB.0028	350 x 110 x 95	Priz Buatı	4	16	94,00



KB.0029



KB.0025



KB.0012



KB.0010



KB.0026



KB.0027



KB.0028

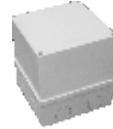

KB.0030



KB.0032



KB.0018



KB.0022



KB.0015

Taban Saçlı Termoplastik Polikarbonat Buatlar

IP54

KOD	CİNSİ		KUTU	KOLİ	FİYAT
KBS.0030	140 x 140 x 145	Termo Pls. Buat	2	24	57,60
KBS.0031	195 x 145 x 145	Termo Pls. Buat	2	9	74,00
KBS.0032	250 x 195 x 145	Termo Pls. Buat	1	9	76,50
KBS.0033	300 x 200 x 145	Termo Pls. Buat	1	9	145,00

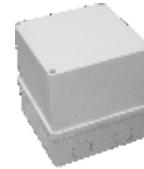

KBS.0030

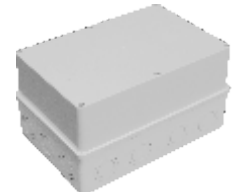

KBS.0032

Şeffaf Kapaklı Termoplastik Buatlar

IP54

KOD	CİNSİ		KUTU	KOLİ	FİYAT
KB.0016-1	125 x 100 x 75	Termo Pls. Buat	8	80	48,00
KB.0024-1	180 x 180 x 80	Termo Pls. Buat	4	36	73,00
KB.0014-1	195 x 145 x 85	Termo Pls. Buat	4	36	83,60
KB.0012-1	250 x 195 x 96	Termo Pls. Buat	2	24	99,80
KB.0011-1	300 x 200 x 125	Termo Pls. Buat	1	15	126,00
KB.0010-1	350 x 255 x 125	Termo Pls. Buat	1	10	143,50



KB.0014-1



KB.0012-1

Sıva Üstü Buatlar

TSE IP54

KOD	cinsi	KUTU	KOLİ	FİYAT	
KB.0355	85 x 85 Kare Antigron Buat	IP 54	10	300	8,50
KB.0356	85 x 50 Nemli Antigron Buat	IP 67	10	240	10,60
KB.0403	90 x 50 Antigron Buat	IP 54	12	240	10,90
KB.0404	110 x 50 Antigron Buat	IP 54	12	144	12,40
KB.0357	110 x 110 x 75 Sıva Üstü Buat	IP 54	10	100	20,80



KB.0355

KB.0356

KB.0357

Sıva Üstü Buatlar

KOD	cinsi	KUTU	KOLİ	FİYAT
KB.0365	180 x 110 x 65 Sıva Üstü Buat	5	75	37,00
KB.0368	220 x 150 x 85 Sıva Üstü Buat	4	36	50,50
KB.0367	235 x 180 x 75 Sıva Üstü Buat	2	36	63,00
KB.0366	260 x 180 x 75 Sıva Üstü Buat	2	24	79,50
KB.0370	320 x 210 x 95 Sıva Üstü Buat	2	24	86,70



KB.0403



KB.0365

Kofralar & Posta Kutusu



KB.5000

NH Polyester Altlıklı Kofra
Koli Adedi: 8
295,00 TL



KB.5006

Polyester Kofra (Boş)
Koli Adedi: 8
280,00 TL



KB.5007

Yük Kesicili Polyester Kofra
Koli Adedi: 8
657,00 TL



KB.5010

NH00 Trifaze Devre Kesen
Kutu Adedi: 10
242,00 TL



KB.5011

NH Monofaze Devre Kesen
Kutu Adedi: 10
129,50 TL



KB.5003

NH 00 Sigorta Ayırıcı (Yük Kesici)
Koli Adedi: 30
365,00 TL



KB.5001

Polyester Buşon
32A. - 160A.
Kutu Adedi: 10
41,00 TL



KB.5002

NH00 Klemensli
Polyester Altlık
Kutu Adedi: 10
41,00 TL



KB.5020

Ölüm Tehlikesi
Levhası
Kutu Adedi: 100
15,00 TL



SM.1846

Posta Kutusu
Koli Adedi: 20
128,00 TL

Telefon Aksesuarları

KOD	CİNSİ	KUTU	FİYAT
TK.1440	6P / 2C Bir Jaklı Telefon Kutusu	50	11,50
TK.1441	6P / 2C İki Jaklı Telefon Kutusu	50	13,80
TK.1442	6P / 2C D.D Adaptör	100	4,60
TK.1443	6P / 2C E.D.D. Adaptör	100	9,20
TK.1444	6P / 2C D.D.D. Adaptör	100	9,20
TK.1445	6P / 2C E.D.D.D. Adaptör	50	16,15
TK.1447	6P / 2C E.D.D.D.D. Adaptör	50	28,50
TK.1448	6P / 4C ITA Adaptör (Mini Fare)	50	15,30
TK.1449	6P / 2C Plug (RJ10)	100	0,56
TK.1450	6P / 4C Plug (RJ11)	100	0,70
TK.1453	YAK 1 Konnektör (Boncuk)	200	0,52
TK.1454	YAK 2 Konnektör	200	0,70
TK.1455	Telefon Kablosu 1,5 mt.	50	9,25
TK.1456	Telefon Kablosu 5 mt.	50	23,10
TK.1457	Telefon Kablosu 10 mt.	50	34,65
TK.1463	Telefon Spirali	25	16,17



Televizyon Aksesuarları

KOD	CİNSİ	KUTU	FİYAT
TK.1460	RG 6 F Konnektör	100	1,21
TK.1461	Plastik Anten Fiş	100	5,10
TK.1462	Plastik Anten Dişi Fiş	100	5,10
TK.1464	Scart / 3RCA Kablo 1,2 mt.	1	34,60
TK.1465	Scart / Scart Kablo 1,2 mt.	1	34,60
TK.1467	Scart / 3RCA Adaptör	1	28,10
TK.1468	Scart / 3RCA Adaptör Switchli	1	32,50
TK.1469	HDMI / HDMI Kablo 1,5 mt.	1	39,30
TK.1470	HDMI / HDMI Kablo 3 mt.	1	69,30



Bilgisayar Aksesuarları

KOD	CİNSİ	KUTU	FİYAT
TK.1451	8P/8C Plug (RJ45 Cat5e)	100	0,75
TK.1493	8P/8C Plug (RJ45 Cat6)	100	1,65
TK.1494	CAT7 / CAT6A Plug + BOOT	100	32,50
TK.1452	ADSL Splitter	50	18,70
TK.1480	Mini ADSL Splitter	1	38,50
TK.1481	8P / 8C D.D. Adaptör	1	5,60
TK.1482	8P / 8C D.D.D. Adaptör	1	13,85
TK.1483	8P / 8C E.D.D. Adaptör	1	13,85
TK.1484	CAT5e Utp Patch Kablo 1 mt.	1	19,90
TK.1485	CAT5e Utp Patch Kablo 2 mt.	1	23,10
TK.1486	CAT5e Utp Patch Kablo 3 mt.	1	30,20
TK.1495	CAT5e Utp Data Kablo	305	3,20
TK.1496	CAT6 Utp Data Kablo	305	4,38
TK.1487	A Erkek - A Dişi Usb Kablosu 1,5 mt.	1	41,80
TK.1488	A Erkek - B Erkek Usb Kablosu 1,5 mt.	1	41,80
TK.1489	A Erkek - B Erkek Usb Kablosu 3 mt.	1	60,50
TK.1490	A Erkek - 5 Pin Erkek Usb Kablosu 1,5 mt.	1	46,00
TK.1491	Power Kablosu (3x0,50)	1	51,00
TK.1492	4P/4C - 6P/6C - 8P/8C Plug Pensesi	1	275,00



Dahili Modül Kutuları - KİLİTLİ



KOD	cinsi	KUTU	FİYAT
TK.0410	Mini Boy Modül Kutusu - ÇATISIZ	45	40,00
TK.0411	1'li Modül Kutusu - Çatılı	45	47,50
TK.0418	2'li Modül Kutusu - Çatılı	45	55,00
TK.0413	Orta Boy Modül Kutusu - ÇATISIZ	30	56,00
TK.0412	3'lü Modül Kutusu - Çatılı	30	78,50
TK.0419	4'lü Modül Kutusu - Çatılı	30	86,00
TK.0414	5'li Modül Kutusu - Çatılı	30	93,50
TK.0415	Büyük Boy Modül Kutusu - ÇATISIZ	20	78,00
TK.0417	10'lu Modül Kutusu - Çatılı	20	153,00



TK.0411



TK.0417



TK.0414



TK.0413

Harici Modül Kutuları ÇATILI

IP54

KOD	cinsi	KUTU	FİYAT
TK.0421	10'lu Harici Telefon Kutusu (IP 54) 20x30x10	15	266,00
TK.0422	20'li Harici Telefon Kutusu (IP 54) 30x40x12	6	472,00
TK.0423	30'lu Harici Telefon Kutusu (IP 54) 40x60x20	3	879,00
TK.0424	50'li Harici Telefon Kutusu (IP 54) 50x70x20	2	1.412,00



TK.0421

Modüller & Paslanmaz Krom Çatılar

KOD	cinsi	KUTU	FİYAT
TK.1320	Kesmesiz Modül	250	26,90
TK.1321	Kesmeli Modül	250	28,00
TK.1325	İrtibatlama Aleti	50	75,00
TK.1324	1'li PASLANMAZ Krom Çatı (h = 4 cm)	-	7,50
TK.1330	2'li PASLANMAZ Krom Çatı (h = 4 cm)	-	15,00
TK.1331	3'lü PASLANMAZ Krom Çatı (h = 4 cm)	-	22,50
TK.1335	4'lü PASLANMAZ Krom Çatı (h = 4 cm)	-	30,00
TK.1332	5'li PASLANMAZ Krom Çatı (h = 4 cm)	-	37,50
TK.1334	10'lu PASLANMAZ Krom Çatı (h = 4 cm)	-	75,00
TK.1336	15'li PASLANMAZ Krom Çatı (h = 4 cm)	-	112,50
TK.1337	20'li PASLANMAZ Krom Çatı (h = 4 cm)	-	150,00



TK.1320



TK.1325



TK.1337

UTP Kablolar

KOD	cinsi	KUTU	FİYAT
TK.1495	CAT5e Utp Data Kablo	305	3,20
TK.1496	CAT6 Utp Data Kablo	305	4,38



TK.1496





GA.0908

Yıldız Armatür
Koli Adedi: 36
37,00 TL



GA.0909

Yıldız Güneş Armatür
Koli Adedi: 36
37,00 TL



GA.0910

Yıldız Gül Armatür
Koli Adedi: 36
37,00 TL



GA.0901

Dolunay Armatür
Koli Adedi: 20
42,00 TL



GA.0904

Dolunay Desenli Armatür
Koli Adedi: 20
42,00 TL



GA.0905

Dolunay Çiçek Armatür
Koli Adedi: 20
42,00 TL



GA.0920

Damla Aplik
Kutu Adedi: 2
Koli Adedi: 32
39,00 TL



GA.0921

Nergiz Aplik
Kutu Adedi: 2
Koli Adedi: 32
39,00 TL



GA.1060

Nehir Aplik
Koli Adedi: 40
39,00 TL



GA.0902

Yeniay Armatür
Koli Adedi: 20
39,00 TL



GA.0906

Yeniay Desenli Armatür
Koli Adedi: 20
39,00 TL



GA.0907

Yeniay Çiçek Armatür
Koli Adedi: 20
39,00 TL

**GA.01033**

ECO Armatür
Kutu Adedi: 6
Koli Adedi:36
32,20 TL

**GA.01035**

ECO Kristal Armatür
Kutu Adedi: 5
Koli Adedi: 60
33,70 TL

**GA.0903**

Hilal Kafesli Armatür
Kutu Adedi: 1
Koli Adedi: 30
33,50 TL

**GA.01890**

Ziya 2 Glop Armatür
Kutu Adedi: 1
Koli Adedi: 30
40,00 TL

**GA.01760**

Ziya 2 Desenli Armatür
Kutu Adedi: 1
Koli Adedi: 30
40,00 TL

**GA.01893-2**

Ziya 4 Oval Armatür Kafesli
Kutu Adedi: 2
Koli Adedi: 48
39,50 TL

**Opak****GA.01892**

Ziya 3 Oval Armatür
Kutu Adedi: 2
Koli Adedi: 48
34,00 TL

**Opak****GA.01893**

Ziya 4 Oval Armatür Kafesli
Kutu Adedi: 2
Koli Adedi: 48
39,50 TL

**Opak****GA.01762**

Ziya 4 Oval Armatür Siperli
Kutu Adedi: 2
Koli Adedi: 48
39,50 TL

**Şeffaf****GA.01892-1**

Ziya 3 Oval Armatür
Kutu Adedi: 2
Koli Adedi: 48
34,00 TL

**Şeffaf****GA.01893-1**

Ziya 4 Oval Armatür Kafesli
Kutu Adedi: 2
Koli Adedi: 48
39,50 TL

**Şeffaf****GA.01762-1**

Ziya 4 Oval Armatür Siperli
Kutu Adedi: 2
Koli Adedi: 48
39,50 TL



GA.1061

Dekoratif Armatür
Mineral Cam - KROM
Koli Adedi:12
215,00 TL



GA.1062

Dekoratif Armatür
Mineral Cam - BEYAZ
Koli Adedi:12
190,00 TL



GA.0810

2 x E27 Duylu Armatür
Kutu Adedi: 1
Koli Adedi:12
45,50 TL



GAS.1403

180° Duvar Tipi
Hareket Sensörü
Koli Adedi: 50
11,00 \$



GAS.1404

360° Tavan Tipi
Hareket Sensörü
Koli Adedi: 50
7,95 \$



GAS.1407

Sıva Altı
Hareket Sensörü
Koli Adedi: 50
7,30 \$



GAS.1408

Radar Sensör
Koli Adedi: 50
8,60 \$

Cadde Armatürleri & Balastlar

KOD	CİNSİ	KUTU	FİYAT
GA.5120	E27 Duylu Boş Cadde Armatürü	1	270,00
GA.5103	Konsol Boru	30	75,00
GA.5104	Boru Monte Kelepçesi	1	11,20



GA.5120



GA.5103

Etanj Armatürler (Elektronik Balastlı)

KOD	CİNSİ	KOLİ	FİYAT
GA.5055	1 x 18 W. Polistren Camlı Arm. (IP65)	24	285,00
GA.5057	1 x 36 W. Polistren Camlı Arm. (IP65)	6	315,00
GA.5056	2 x 18 W. Polistren Camlı Arm. (IP65)	12	300,00
GA.5058	2 x 36 W. Polistren Camlı Arm. (IP65)	6	343,00



GA.5055



GA.5058



2xE27 Duyulu

GA.0802

360° Hareket Sensörlü
Armatür Güneş Desenli
Koli Adedi: 12

123,00 TL



2xE27 Duyulu

GA.0804

360° Hareket Sensörlü
Armatür Yıldız Desenli
Koli Adedi: 12

123,00 TL



2xE27 Duyulu

GA.0805

360° Hareket Sensörlü
Armatür Kristal Desenli
Koli Adedi: 12

123,00 TL



2xE27 Duyulu

GA.2096

360° Hareket Sensörlü
Metal Gövde Cam Armatür
Koli Adedi: 10

136,00 TL



Kitli & Ledli

GLA.0806

360° Hareket Sensörlü
18W LEDLİ Arm. (PİLLİ)
Koli Adedi: 12

325,00 TL



Ledli

GLA.0807

360° Hareket Sensörlü
18W LEDLİ Arm. (PİLSİZ)
Koli Adedi: 12

204,00 TL



2xE27 Duyulu Kitli

GA.2098

360° Hareket Sensörlü
Acil Çıkış Arm. (Şarjlı Pili)
Koli Adedi: 10

268,50 TL

YENİ
ÜRÜN

Ledli

GLA.0860

İNCİ Oval Kafesli
Armatür 30 Ledli 7W
Koli Adedi: 36

95,00 TL



E27 Duyulu

GA.0820

180° Hareket Sensörlü
Duvar Aplik
Koli Adedi: 20

121,00 TL



Ledli

GA.0822

180° Hareket Sensörlü
30 Ledli 7W Aplik
Koli Adedi: 20

210,00 TL

YENİ
ÜRÜN

Kitli & Ledli

GA.0823

180° Hareket Sensörlü
30 Ledli 7W Aplik KİTLİ
Koli Adedi: 20

295,00 TL



Ledli

GLA.5201

18W Dekoratif Armatür
Mineral Cam - KROM
Koli Adedi: 12

355,00 TL



Ledli

GLA.5202

18W Dekoratif Armatür
Mineral Cam - BEYAZ
Koli Adedi: 12

312,00 TL



VT.891038

Ledli Duvar Lambası
Tekli
Koli Adedi: 36

70,00 TL



GLA.35218

18W Sıva Üstü Kare Led
Lümen 1200
Ölçü 225 mm
Koli Adedi: 20
150,00 TL



GLA.35224

24W Sıva Üstü Kare Led
Lümen 1560
Ölçü 300 mm
Koli Adedi: 10
228,80 TL



GLA.35118

18W Sıva Üstü YuvarlakLed
Lümen 800
Çapı 165 mm
Koli Adedi: 30
140,00 TL



GLA.35124

24W Sıva Üstü YuvarlakLed
Lümen 1200
Çapı 215 mm
Koli Adedi: 20
215,00 TL



GLA.35303

3+3W Çift Renkli Led Panel
Lümen 130
Kesim Çapı: 75 mm
Koli Adedi: 60
71,50 TL



GLA.35306

6+3W Çift Renkli Led Panel
Lümen 330
Kesim Çapı: 100 mm
Koli Adedi: 40
128,50 TL



GLA.5205

20W Ufo Led Ampul
Lümen 1600
Koli Adedi: 50
71,50 TL



GLA.5206

36W Ufo Led Ampul
2500 Lümen
Koli Adedi: 30
128,50 TL



GLA.5236

36W Bant Armatür
Lümen 2500
Koli Adedi: 40
86,00 TL



GLA.35003

3W Sıva Altı Led Panel
Lümen 120
Kesim Çapı: 75 mm
Koli Adedi: 50
42,80 TL



GLA.35006

6W Sıva Altı Led Panel
Lümen 300
Kesim Çapı: 106 mm
Koli Adedi: 50
51,50 TL



GLA.35009

9W Sıva Altı Led Panel
Lümen 520
Kesim Çapı: 135 mm
Koli Adedi: 40
66,00 TL



GLA.35012

12W Sıva Altı Led Panel
Lümen 800
Kesim Çapı: 155 mm
Koli Adedi: 30
74,20 TL



GLA.35015

15W Sıva Altı Led Panel
Lümen 900
Kesim Çapı: 175 mm
Koli Adedi: 20
81,40 TL



GLA.35018

18W Sıva Altı Led Panel
Lümen 1200
Kesim Çapı: 225 mm
Koli Adedi: 40
97,35 TL



GLA.35305

5W 3 Renkli Led Spot
Lümen 210
Koli Adedi: 100
51,00 TL



GLA.5010

10W Led Projektör
Lümen 600
Koli Adedi: 40
123,00 TL



GLA.5010-Y

10W Led Projektör
Lümen 600
Koli Adedi: 40
151,00 TL



GLA.5030

30W Led projektör
Lümen 1800
Koli Adedi: 10
189,00 TL



GLA.5050

50W Led projektör
Lümen 3250
Koli Adedi: 10
269,00 TL



GLA.5050-Y

50W Led projektör
Lümen 3250
Koli Adedi: 10
290,00 TL



GLA.5100

100W Led projektör
Lümen 5500
Koli Adedi: 5
317,00 TL



GLA.5100-Y

100W Led projektör
Lümen 5500
Koli Adedi: 5
331,00 TL

5 Otomat Kapasiteli Kombinasyon Kutusu 215x115x115

ABS

KOD	cinsi	KOLİ	FİYAT
KB.0060	Boş 1'li Kombinasyon Kutusu (IP 54)	20	81,70
KB.0060-1	Boş 1'li Kombinasyon Kutusu Delikli	20	81,70



KB.0060

9 Otomat Kapasiteli Kombinasyon Kutusu 250x190x120

ABS

KOD	cinsi	KOLİ	FİYAT
KB.0050	Boş 2'li Kombinasyon Kutusu (IP 54)	18	139,00
KB.0050-1	Boş 2'li Kombinasyon Kutusu Delikli	18	139,00



KB.0050-1

9 Otomat Kapasiteli Kombinasyon Kutusu 300x200x135

ABS

KOD	cinsi	KOLİ	FİYAT
KB.0070	Boş 4'lü Kombinasyon Kutusu (IP 54)	10	181,00
KB.0070-1	Boş 4'lü Kombinasyon Kutusu Delikli	10	181,00



KB.0070

12 Otomat Kapasiteli Kombinasyon Kutusu 350x255x135

ABS

KOD	cinsi	KOLİ	FİYAT
KB.0080	Boş 6'lı Kombinasyon Kutusu (IP 54)	10	241,00
KB.0080-1	Boş 6'lı Kombinasyon Kutusu Delikli	10	241,00



KB.0080-1

Eko Kombinasyon Kutuları - PRİZLİ 5 Otomatlı 215x115x115

ABS

KOD	cinsi	KOLİ	FİYAT
KP0180	1 Ad. 3x25 Ön / 2 Ad. 1x16 Yan	20	139,50
KP0181	1 Ad. 5x16 Ön / 2 Ad. 1x16 Yan	20	204,00
KP0186	1 Ad. 5x32 Ön / 2 Ad. 1x16 Yan	20	229,00



KP0180



KP0186

*Prizler montajsızdır.

Eko Kombinasyon Kutuları - PRİZLİ 9 Otomatlı 250x190x120

ABS

KOD	cinsi	KOLİ	FİYAT
KP0280	2 Ad. 3x25 Ön / 2 Ad. 1x16 Yan	12	217,50
KP0281	2 Ad. 5x16 Ön / 2 Ad. 1x16 Yan	18	345,00
KP0286	2 Ad. 5x32 Ön / 2 Ad. 1x16 Yan	18	396,00



KP0280



KP0286

*Prizler montajsızdır.

ABS Kombinasyon Kutuları - BOŞ

ABS

KOD	cinsi		KOLİ	FİYAT
KB.0481	1'li Kombinasyon Kutusu	6 Otom	20	98,70
KB.0481-1	1'li Kombinasyon Kutusu Delikli	6 Otom	20	98,70
KB.0482	2'li Kombinasyon Kutusu	11 Otom	12	173,50
KB.0482-1	2'li Kombinasyon Kutusu Delikli	11 Otom	12	173,50



KB.0481
220 x 130 x 115
6W Oto. Kap.



ABS Kombinasyon Kutuları -BOŞ &A.Yaymaz



ABS

KOD	cinsi		KOLİ	FİYAT
KBH.0481	1'li Komb. Kutusu H.F.&A.Yaymaz	6 Otom	20	149,00
KBH.0481-1	1'li Komb. Kutusu Delikli H.F.&A.Yaymaz	6 Otom	20	149,00
KBH.0482	2'li Komb. Kutusu H.F.&A.Yaymaz	11 Otom	12	228,00
KBH.0482-1	2'li Komb. Kutusu Delikli H.F.&A.Yaymaz	11 Otom	12	228,00



KB.0482
310 x 225 x 120
11W Oto. Kap.



ABS Kombinasyon Kutuları - PRİZLİ 6 Otomatlı

ABS

KOD	cinsi		KOLİ	FİYAT
KB.0481-2	1 Ad. 3x25 Ön / 2 Ad. 1x16 Yan		20	157,50
KB.0481-3	1 Ad. 5x16 Ön / 2 Ad. 1x16 Yan		20	222,00
KB.0481-4	1 Ad. 5x32 Ön / 2 Ad. 1x16 Yan		20	247,00



KB.0481-3

*Prizler montajsızdır.

ABS Kombinasyon Kutuları - PRİZLİ 11 Otomatlı

ABS

KOD	cinsi		KOLİ	FİYAT
KB.0482-2	2 Ad. 3x25 Ön / 2 Ad. 1x16 Yan		12	300,00
KB.0482-3	2 Ad. 5x16 Ön / 2 Ad. 1x16 Yan		12	389,00
KB.0482-4	2 Ad. 5x32 Ön / 2 Ad. 1x16 Yan		12	439,00



KB.0482-2

*Prizler montajsızdır.

Kombinasyon Kutuları İçin Uygulanabilir Prizler



TNP298

1/16A Pano Priz
Kutu Adedi: 50
15,50 TL



TNP299

1/16A Makine Priz
Kutu Adedi: 20
18,50 TL



TNP318

3/25A Makine Priz
Kutu Adedi: 30
30,00 TL



TRİ.307

5/16A Makine Priz
Kutu Adedi: 18
94,00 TL



TRİ.317

5/32A Makine Priz
Kutu Adedi: 12
119,00 TL



BY8-1402-2700

1/16A Pano Priz
Kutu Adedi: 30
37,00 TL



BP1-1402-2410

1/16A Makine Priz
Kutu Adedi: 18
46,30 TL



BP2-2504-4415

3/25A Makine Priz
Kutu Adedi: 18
60,00 TL



BC1-1505-2413

5/16A Makine Priz
Kutu Adedi: 15
132,75 TL



BC1-3505-2413

5/32A Makine Priz
Kutu Adedi: 8
164,75 TL

Kasa & Buatlar



KOD	CİNSİ	ÇUVAL	PAKET	FİYAT
PK.0634	Geçmeli Kasa KAPAKSIZ	1000	100	3,20
PK.0639	Geçmeli Kasa KAPAKLI	1000	100	3,45
PK.0629	Geçmeli Derin Kasa KAPAKSIZ	1000	50	3,66
PK.0628	Geçmeli Derin Kasa KAPAKLI	500	50	4,05
PK.0637	Norm Kasa	1000	100	2,76
PK.0638	Norm Buat	500	50	3,90
PK.0641	Norm Buat KAPAKSIZ	500	50	3,44



PK.0629



PK.0638



PK.0637

Alçıpan Kasa & Buatlar



KOD	CİNSİ	ÇUVAL	PAKET	FİYAT
PK.0630	Alçıpan Kasa	800	50	4,80
PK.0640	Alçıpan Kasa GEÇMELİ	800	50	5,16
PK.0652	Alçıpan Kasa 2'li	-	60	7,70
PK.0653	Alçıpan Kasa 3'lü	-	40	10,00
PK.0654	Alçıpan Kasa 4'lü	-	28	12,30
PK.0655	Alçıpan Kasa 5'li	-	24	16,20
PK.0656	Alçıpan Kasa 6'lı	-	20	20,00
PK.0632	Alçıpan Buat	500	60	12,40
PK.0642	Plastik Takoz 14-18	1000	100	2,98



PK.0630



PK.0640



PK.0632



PK.0642



PK.0656

Tünel Kalıp Kasalar



KOD	CİNSİ	ÇUVAL	PAKET	FİYAT
PK.0622	Tavan Askı Kasası Komple	500	50	4,66
PK.0625	Buat Kasası Komple	500	50	5,24
PK.0627	Anahtar Kasası Komple	500	50	5,17
PK.0631	Tünel Kalıp Beton Buat	500	50	5,46
AV.7005	M5 Tavan Askısı (85 mm.) (1 Ad. Fiyatı)	-	50	1,65



AV.7005



PK.0622



PK.0625



PK.0627



PK.0631

Boru İniş Takozları

KOD	CİNSİ	ÇUVAL	PAKET	FİYAT
PB.0719	18'lik İkili Boru İniş Takozu	500	100	0,54
PB.0720	18'lik Üçlü Boru İniş Takozu	500	100	0,76
PB.0721	20'lik Üçlü Boru İniş Takozu	500	100	0,82
PB.0722	32'lik Tekli Boru İniş Takozu	500	100	0,74



Kasa & Buatlar

KOD	CİNSİ	ÇUVAL	PAKET	FİYAT
PK.0566	Geçmeli Derin Kasa KAPAKSIZ	1000	50	1,62
PK.0564	Geçmeli Derin Kasa KAPAKLI	500	50	1,92
PK.0552	Norm Kasa	1000	100	1,86
PK.0569	Norm Buat KAPAKSIZ	500	50	2,44
PK.0558	Norm Buat KAPAKLI	500	50	2,72
PK.0565	Geçmeli Kasa KAPAKSIZ	1000	100	1,56
PK.0554	Geçmeli Kasa KAPAKLI	1000	100	1,84
PK.0561	Alçıpan Kasa GEÇMELİ	800	50	4,40
PK.0555	Alçıpan Kasa	800	50	4,30
PK.0559	Beton Buat	500	50	7,90
PK.0562	Plastik Takoz 14 - 18	1000	100	1,76



Lüks Buat Kapakları

KOD	CİNSİ	KUTU	KOLİ	FİYAT
LBK.0991	Lüks Buat Kapağı Düz	100	1600	1,14
LBK.0992	Lüks Buat Kapağı Bombeli	100	1600	1,20
LBK.0993	Lüks Buat Kapağı Kare	100	1500	1,50
LBK.0994	Lüks Buat Kapağı Vidalı Pls.	100	1600	1,64
LBK.0995	Lüks Buat Kapağı Büyük 100 mm.	100	1600	1,60



Sıva Altı Kare Buatlar (ABS)

KOD	CİNSİ	KUTU	KOLİ	FİYAT
KB.0351	100 x 100 x 45 Kare Buat	10	200	17,00
KB.0352	120 x 120 x 48 Kare Buat	10	150	19,00
KB.0353	150 x 150 x 52 Kare Buat	10	100	20,70
KB.0354	200 x 200 x 55 Kare Buat	10	80	23,00



Sıva Altı Polikarbonat Kare Buatlar



KOD	CİNSİ	KUTU	KOLİ	FİYAT
KB.0034	100 x 100 x 45 Kare Buat H.F. IP 40	10	200	19,70
KB.0035	120 x 120 x 48 Kare Buat H.F. IP 40	10	150	23,40
KB.0036	150 x 150 x 52 Kare Buat H.F. IP 40	10	100	26,00
KB.0037	200 x 200 x 55 Kare Buat H.F. IP 40	10	80	29,60

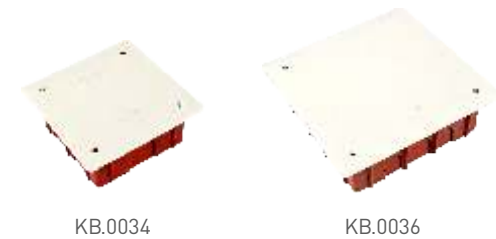

Sıva Altı Kare Buat Kapakları

KOD	CİNSİ	ÇUVAL	FİYAT
KB.0361	100 x 100 Kare Buat Kapağı	500	3,90
KB.0362	120 x 120 Kare Buat Kapağı	400	5,10
KB.0363	150 x 150 Kare Buat Kapağı	300	7,20
KB.0364	200 x 200 Kare Buat Kapağı	200	9,40



Kablo Toplama Spiralleri - GRİ - SİYAH

KOD	CİNSİ	METRE	FİYAT
KTS.3020	Ø 20 Kablo Toplama Spirali Gri	25	11,90
KTS.3020-1	Ø 20 Kablo Toplama Spirali Siyah	25	11,90
KTS.3025	Ø 25 Kablo Toplama Spirali Gri	20	15,20
KTS.3025-1	Ø 25 Kablo Toplama Spirali Siyah	20	15,20
KTS.3030	Ø 30 Kablo Toplama Spirali Gri	15	18,90
KTS.3030-1	Ø 30 Kablo Toplama Spirali Siyah	15	18,90
KTS.4001	Ø 20 Uygulama Aparatı	1 Ad.	3,40
KTS.4002	Ø 25 Uygulama Aparatı	1 Ad.	4,50
KTS.4003	Ø 30 Uygulama Aparatı	1 Ad.	6,70



Kablo Toplama Spiralleri - GRİ - SİYAH 1,5 mt'lik

KOD	CİNSİ	ADET	FİYAT
KTS.4020	Ø 20 Kablo Toplama Spirali Gri Uygulama Aparatlı	1	30,50
KTS.4020-1	Ø 20 Kablo Toplama Spirali Siyah Uygulama Aparatlı	1	30,50
KTS.4025	Ø 25 Kablo Toplama Spirali Gri Uygulama Aparatlı	1	34,65
KTS.4025-1	Ø 25 Kablo Toplama Spirali Siyah Uygulama Aparatlı	1	34,65
KTS.4030	Ø 30 Kablo Toplama Spirali Gri Uygulama Aparatlı	1	41,80
KTS.4030-1	Ø 30 Kablo Toplama Spirali Siyah Uygulama Aparatlı	1	41,80



Kablo Toplayıcı Omurga

KOD	CİNSİ	METRE	FİYAT
KTS.3200	Kablo Toplayıcı (Omurga Model) (75 cm) Gri	1	215,00
KTS.3200-1	Kablo Toplayıcı (Omurga Model) (75 cm) Siyah	1	215,00



Helezon Pano Spiralleri (50 cm)

KOD	CİNSİ	ÇUVAL	ADET	FİYAT
PS.1738	No.1 (6 mm) Helezon Pano Spirali	4.000	100	1,37
PS.1739	No.2 (8 mm) Helezon Pano Spirali	2.000	100	1,45
PS.1741	No.3 (11 mm) Helezon Pano Spirali	1.500	100	1,95
PS.1742	No.4 (14 mm) Helezon Pano Spirali	800	50	3,20
PS.1743	No.5 (17 mm) Helezon Pano Spirali	800	50	4,95

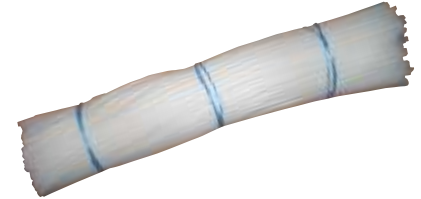

Helezon Pano Spiralleri

KOD	CİNSİ	PAKET	METRE	FİYAT
PS.1738-1	No.1 (6 mm) Helezon Pano Spirali	1	10	2,74
PS.1739-1	No.2 (8 mm) Helezon Pano Spirali	1	10	2,90
PS.1741-1	No.3 (11 mm) Helezon Pano Spirali	1	10	3,90
PS.1742-1	No.4 (14 mm) Helezon Pano Spirali	1	10	6,40
PS.1743-1	No.5 (17 mm) Helezon Pano Spirali	1	10	9,90



Koruge Borular & Manşonlar

KOD	CİNSİ	İÇ ÇAP mm	DIŞ ÇAP mm	METRE	FİYAT
KRG.1050	50 mm. Koruge Kangal Boru	43	50	100	Arayınız
KRG.1063	63 mm. Koruge Kangal Boru	54	63	100	Arayınız
KRG.1075	75 mm. Koruge Kangal Boru	64	75	100	Arayınız
KRG.1100	100 mm. Koruge Boy Boru	85	100	6	Arayınız
KRG.1115	115 mm. Koruge Boy Boru	100	115	6	Arayınız
KRG.1150	150 mm. Koruge Boy Boru	140	150	6	Arayınız
KRM.1100	100 mm. Manşon	-	-	-	Arayınız
KRM.1115	115 mm. Manşon	-	-	-	Arayınız
KRM.1150	150 mm. Manşon	-	-	-	Arayınız



Polietilen Kangal Borular (Hafif Seri) - SİYAH

KOD	CİNSİ	METRE	FİYAT
PB.17114	Ø 14 Kangal Boru	100	2,75
PB.17116	Ø 16 Kangal Boru	100	3,25
PB.17118	Ø 18 Kangal Boru	100	3,70
PB.17120	Ø 20 Kangal Boru	100	4,95
PB.17125	Ø 25 Kangal Boru	100	6,70
PB.17132	Ø 32 Kangal Boru	100	11,00
PB.17140	Ø 40 Kangal Boru	100	15,50
PB.17150	Ø 50 Kangal Boru	100	23,30



Polietilen Kangal Borular Turuncu (6 ATÜ)

KOD	CİNSİ	METRE	FİYAT
PB.17314	Ø 14 Kangal Boru - TURUNCU	100	3,20
PB.17316	Ø 16 Kangal Boru - TURUNCU	100	3,85
PB.17318	Ø 18 Kangal Boru - TURUNCU	100	4,40
PB.17320	Ø 20 Kangal Boru - TURUNCU	100	5,80
PB.17325	Ø 25 Kangal Boru - TURUNCU	100	8,15
PB.17332	Ø 32 Kangal Boru - TURUNCU	100	12,00
PB.17340	Ø 40 Kangal Boru - TURUNCU	100	19,70
PB.17350	Ø 50 Kangal Boru - TURUNCU	100	30,20



Polietilen Kangal Borular Turuncu (10 ATÜ)

KOD	CİNSİ	METRE	FİYAT
PB.17414	Ø 14 Kangal Boru - TURUNCU	100	3,85
PB.17416	Ø 16 Kangal Boru - TURUNCU	100	4,55
PB.17418	Ø 18 Kangal Boru - TURUNCU	100	5,40
PB.17420	Ø 20 Kangal Boru - TURUNCU	100	6,60
PB.17425	Ø 25 Kangal Boru - TURUNCU	100	9,80
PB.17432	Ø 32 Kangal Boru - TURUNCU	100	14,90
PB.17440	Ø 40 Kangal Boru - TURUNCU	100	21,30
PB.17450	Ø 50 Kangal Boru - TURUNCU	100	32,50



Muflar & Dirsekler



KOD	CİNSİ	PAKET	FİYAT
PB.1633	16 mm. Halogen Free Muf	100	2,95
PB.1634	20 mm. Halogen Free Muf	100	3,35
PB.1635	25 mm. Halogen Free Muf	100	4,60
PB.1636	32 mm. Halogen Free Muf	100	6,65
PB.1630	16 mm. Halogen Free Dirsek	100	3,95
PB.1631	20 mm. Halogen Free Dirsek	100	5,20
PB.1632	25 mm. Halogen Free Dirsek	100	6,45
PB.1629	32 mm. Halogen Free Dirsek	100	9,40



PB.1632



PB.1634

Dirsekler & Muflar

KOD	CİNSİ	ÇUVAL	PAKET	FİYAT
PB.0716	14'lük Plastik Dirsek	5.000	500	0,55
PB.0717	18'lik Plastik Dirsek	3.000	250	0,75
PB.0718	26'lık Plastik Dirsek	1.000	100	2,20
PB.0725	14'lük Plastik Muf	2.000	100	0,55
PB.0726	18'lik Plastik Muf	1.000	100	0,75
PB.0727	26'lık Plastik Muf	500	50	2,20



PB.0716



PB.0725

Çelik Spiral

KOD	cinsi	İÇ ÇAP mm	DIŞ ÇAP mm	METRE	FIYAT
PS.15609	Ø 9 Çelik Spiral	9.00	11.50	50	4,65
PS.15611	Ø 11 Çelik Spiral	11.00	14.00	50	5,61
PS.15614	Ø 14 Çelik Spiral	14.00	17.00	50	7,00
PS.15616	Ø 16 Çelik Spiral	16.00	19.00	50	8,00
PS.15618	Ø 18 Çelik Spiral	18.00	21.00	50	9,42
PS.15621	Ø 21 Çelik Spiral	21.00	24.00	50	11,25
PS.15626	Ø 26 Çelik Spiral	25.50	30.00	25	14,00
PS.15632	Ø 32 Çelik Spiral	32.00	35.00	25	16,90
PS.15637	Ø 37 Çelik Spiral	37.00	41.00	25	19,70
PS.15642	Ø 42 Çelik Spiral	42.00	46.00	25	23,65
PS.15650	Ø 50 Çelik Spiral	50.00	55.00	25	28,40



Pvc İzoleli Çelik Spiral

KOD	cinsi	İÇ ÇAP mm	DIŞ ÇAP mm	METRE	FIYAT
PS.15811	Ø 11 İzoleli Çelik Spiral	11.00	15.00	50	6,55
PS.15814	Ø 14 İzoleli Çelik Spiral	14.00	18.00	50	7,80
PS.15816	Ø 16 İzoleli Çelik Spiral	16.00	20.00	50	10,90
PS.15818	Ø 18 İzoleli Çelik Spiral	18.00	22.00	50	12,65
PS.15821	Ø 21 İzoleli Çelik Spiral	21.00	25.00	50	15,00
PS.15826	Ø 26 İzoleli Çelik Spiral	25.50	31.00	25	18,80
PS.15832	Ø 32 İzoleli Çelik Spiral	32.00	36.00	25	22,45
PS.15837	Ø 37 İzoleli Çelik Spiral	37.00	42.00	25	26,65
PS.15842	Ø 42 İzoleli Çelik Spiral	42.00	47.00	25	31,55
PS.15850	Ø 50 İzoleli Çelik Spiral	50.00	55.00	25	37,40



Pvc İzoleli Spiral - KILAVUZ TELLİ

KOD	cinsi	İÇ ÇAP mm	DIŞ ÇAP mm	METRE	FIYAT
PSK.15911	Ø 11 İzoleli Çelik Spiral	11.00	15.00	50	8,05
PSK.15914	Ø 14 İzoleli Çelik Spiral	14.00	18.00	50	9,30
PSK.15916	Ø 16 İzoleli Çelik Spiral	16.00	20.00	50	12,40
PSK.15918	Ø 18 İzoleli Çelik Spiral	18.00	22.00	50	14,15
PSK.15921	Ø 21 İzoleli Çelik Spiral	21.00	25.00	50	16,50
PSK.15926	Ø 26 İzoleli Çelik Spiral	25.50	31.00	25	20,30
PSK.15932	Ø 32 İzoleli Çelik Spiral	32.00	36.00	25	23,95
PSK.15937	Ø 37 İzoleli Çelik Spiral	37.00	42.00	25	28,15
PSK.15942	Ø 42 İzoleli Çelik Spiral	42.00	47.00	25	33,05



Polietilen Spiral Borular - SİYAH

KOD	CİNSİ	İÇ ÇAP mm	DIŞ ÇAP mm	METRE	FİYAT
PS.15109	10'lük Spiral Boru	10.00	13.00	100	1,85
PS.15112	12'lik Spiral Boru	12.20	15.80	100	1,95
PS.15114	14'lük Spiral Boru	15.00	18.50	100	2,10
PS.15118	18'lik Spiral Boru	18.00	21.50	50	2,85
PS.15120	20'lik Spiral Boru	20.80	24.50	50	3,50
PS.15125	25'lik Spiral Boru	25.40	29.20	50	4,20
PS.15132	32'lik Spiral Boru	29.20	35.00	50	7,30
PS.15137	37'lik Spiral Boru	37.50	41.70	50	9,70



Polietilen Spiral Borular - GRİ

KOD	CİNSİ	İÇ ÇAP mm	DIŞ ÇAP mm	METRE	FİYAT
PS.15112-1	12'lik Spiral Boru	12.20	15.80	100	2,45
PS.15114-1	14'lük Spiral Boru	15.00	18.50	100	2,95
PS.15118-1	18'lik Spiral Boru	18.00	21.50	50	4,45
PS.15120-1	20'lik Spiral Boru	20.80	24.50	50	5,40
PS.15125-1	25'lik Spiral Boru	25.40	29.20	50	6,50



PP Polypropilen Spiral Borular



KOD	CİNSİ	İÇ ÇAP mm	DIŞ ÇAP mm	METRE	FİYAT
PS.15209	PG 9 Spiral Boru	10.00	13.00	100	0,350 €
PS.15211	PG 11 Spiral Boru	12.40	16.00	100	0,380 €
PS.15213	PG 13,5 Spiral Boru	14.40	18.50	50	0,500 €
PS.15216	PG 16 Spiral Boru	17.00	21.40	50	0,550 €
PS.15220	20'lik Spiral Boru	20.80	24.80	50	0,730 €
PS.15221	PG 21 Spiral Boru	23.20	28.70	50	0,770 €
PS.15229	PG 29 Spiral Boru	29.00	34.50	25	0,930 €



PA Polyamid Spiral Boru - ALEV YAYMAZ



KOD	CİNSİ	İÇ ÇAP mm	DIŞ ÇAP mm	METRE	FİYAT
PS.15309	PG 9 Polyamid Spiral Boru	10.00	13.00	100	0,510 €
PS.15311	PG 11 Polyamid Spiral Boru	12.40	16.00	100	0,700 €
PS.15313	PG 13,5 Polyamid Spiral Boru	14.40	18.50	50	0,780 €
PS.15316	PG 16 Polyamid Spiral Boru	17.00	21.40	50	0,980 €
PS.15321	PG 21 Polyamid Spiral Boru	23.20	28.70	50	1,540 €
PS.15329	PG 29 Polyamid Spiral Boru	29.00	34.50	25	1,820 €
PS.15336	PG 36 Polyamid Spiral Boru	36.00	42.50	25	4,600 €



PG Dış Geçmeli Spiral Rakorlar

KOD	CİNSİ	ADET	FİYAT
CR.2949	PG 9 Geçmeli Spiral Rakoru	50	0,560 €
CR.2950	PG 11 Geçmeli Spiral Rakoru	50	0,650 €
CR.2951	PG 13,5 Geçmeli Spiral Rakoru	75	0,740 €
CR.2952	PG 16 Geçmeli Spiral Rakoru	50	0,930 €
CR.2953	PG 21 Geçmeli Spiral Rakoru	25	1,500 €
CR.2954	PG 29 Geçmeli Spiral Rakoru	20	1,930 €
CR.2955	PG 36 Geçmeli Spiral Rakoru	15	2,660 €



PVC Düz Boru - Alev Yayımayan

KOD	CİNSİ	METRE	FİYAT
PB.17916	Ø 16 PVC Düz Boru - Hafif Seri	102	9,70
PB.17920	Ø 20 PVC Düz Boru - Hafif Seri	102	12,50
PB.17925	Ø 25 PVC Düz Boru - Hafif Seri	51	18,80
PB.17932	Ø 32 PVC Düz Boru - Hafif Seri	45	24,40



PVC Düz Boru Aksesuarları

KOD	CİNSİ	PAKET	FİYAT
PBA.17116	Ø 16 PVC Alev Yayımaz Dirsek	100	3,95
PBA.17120	Ø 20 PVC Alev Yayımaz Dirsek	100	5,20
PBA.17125	Ø 25 PVC Alev Yayımaz Dirsek	100	6,45
PBA.17132	Ø 32 PVC Alev Yayımaz Dirsek	50	9,40
PBA.17216	Ø 16 PVC Alev Yayımaz Ek Mufu	100	2,90
PBA.17220	Ø 20 PVC Alev Yayımaz Ek Mufu	100	3,35
PBA.17225	Ø 25 PVC Alev Yayımaz Ek Mufu	100	4,60
PBA.17232	Ø 32 PVC Alev Yayımaz Ek Mufu	50	6,65
PBA.17316	Ø 16 PVC Alev Yayımaz Düz Boru Rakoru	100	6,65
PBA.17320	Ø 20 PVC Alev Yayımaz Düz Boru Rakoru	100	7,30
PBA.17325	Ø 25 PVC Alev Yayımaz Düz Boru Rakoru	100	8,35
PBA.17332	Ø 32 PVC Alev Yayımaz Düz Boru Rakoru	50	10,40



Yarım Ay Kroşe & Kapaklı Yarım Ay Kroşe

KOD	CİNSİ	PAKET	FİYAT
SH.1616	16'lik Ay Kroşe GEÇMELİ	100	1,80
SH.2020	20'lik Ay Kroşe GEÇMELİ	100	1,95
SH.2525	25'lik Ay Kroşe GEÇMELİ	100	2,10
SH.3232	32'lik Ay Kroşe GEÇMELİ	100	3,15
SH.1616-1	16'lik Ay Kroşe GEÇMELİ KAPAKLI	100	1,25
SH.2020-1	20'lik Ay Kroşe GEÇMELİ KAPAKLI	100	1,46
SH.2525-1	25'lik Ay Kroşe GEÇMELİ KAPAKLI	100	1,67
SH.3232-1	32'lik Ay Kroşe GEÇMELİ KAPAKLI	100	2,10

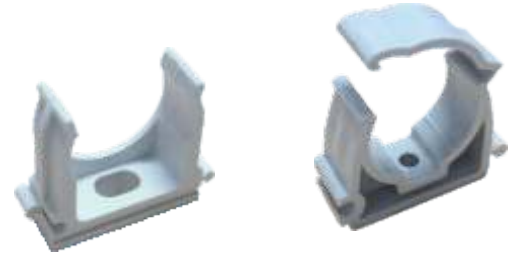

SH.1616

SH.1616-1

*Halogen-Free, Alev Yayımaz

Plastik Sustalar (Takviyeli)

KOD	CİNSİ	ADET	FİYAT
S.1926	10 mt. Plastik Susta Takviyeli	25	40,80
S.1927	15 mt. Plastik Susta Takviyeli	20	61,20
S.1928	20 mt. Plastik Susta Takviyeli	15	81,60
S.1929	25 mt. Plastik Susta Takviyeli	13	102,00
S.1930	30 mt. Plastik Susta Takviyeli	10	122,40



Plastik Sustalar - ALMAN

KOD	CİNSİ	ADET	FİYAT
S.1926-1	10 mt. Plastik Susta (3 mm)	50	116,00
S.1927-1	15 mt. Plastik Susta (3 mm)	40	123,00
S.1928-1	20 mt. Plastik Susta (4 mm)	25	204,00
S.1929-1	25 mt. Plastik Susta (4 mm)	20	257,00
S.1930-1	30 mt. Plastik Susta (4 mm)	15	299,00



*Stok Sorunuz

Takviyeli Çelik Sustalar Kılavuz Telli

KOD	CİNSİ	ADET	FİYAT
S.1917	10 mt. Çelik Susta Takviyeli	25	80,00
S.1918	15 mt. Çelik Susta Takviyeli	20	120,00
S.1919	20 mt. Çelik Susta Takviyeli	15	160,00
S.1920	25 mt. Çelik Susta Takviyeli	13	200,00
S.1922	50 mt. Çelik Susta Takviyeli	5	400,00



Beton Çivili Kroşeler - GÖÇMEN

KOD	CİNSİ	ÖLÇÜ	PAKET	KOLİ	FİYAT
BÇK.1110	No.0 0,75 Yassı Kordon	5 mm	1.000	40.000	0,122
BÇK.1111	No.1 0,75 Yuv. Kordon	5 mm	1.000	40.000	0,122
BÇK.1112	No.2 0,75 TTR.	6 mm	1.000	40.000	0,122
BÇK.1113	No.3 2x1,5 Antigron	7 mm	1.000	24.000	0,168
BÇK.1114	No.4 2x4 Antigron	10 mm	1.000	24.000	0,168
BÇK.1115	No.5 4x4 Antigron	10 mm	1.000	20.000	0,224
BÇK.1116	No.6 4x6 Antigron	14 mm	1.000	18.000	0,224
BÇK.1117	No.7 4x10 Antigron	20 mm	800	10.000	0,392
BÇK.1118	No.8 3x16+10 Antigron	20 mm	400	5.000	0,478
BÇK.1119	No.9 3x25+16 Antigron	22 mm	400	5.000	0,584



BÇK.1111

BÇK.1114

BÇK.1118

Paspayları

KOD	CİNSİ	DEMİR ÇAPI	ÇUVAL	PAKET	FİYAT
PB.1650	25'lik Döşeme Perde Paspayı	16-22	5000	1000	1,20
PB.1651	30'luk Döşeme Perde Paspayı	10-22	5000	1000	1,25
PB.1652	20 mm Norm Tipi Paspayı	8-24	-	1000	0,88
PB.1653	25 mm Norm Tipi Paspayı	8-24	-	1000	0,90
PB.1654	30 mm Norm Tipi Paspayı	8-24	-	1000	1,10
PB.1655	40 mm Norm Tipi Paspayı	8-24	-	1000	1,25
PB.1656	50 mm Norm Tipi Paspayı	8-24	-	1000	1,40



PB.1651



PB.1652

Tandır Kroşeler

KOD	CİNSİ	KUTU	FİYAT
GK.1115	No.1 Tandır Kroşe (2 x 6)	350	2,40
GK.1116	No.2 Tandır Kroşe (4 x 6)	250	2,40
GK.1117	No.3 Tandır Kroşe (4 x 10)	250	2,40
GK.1118	No.4 Tandır Kroşe (4 x 16)	150	2,85
GK.1119	No.5 Tandır Kroşe (3 x 25 + 16)	150	2,85



GK.1115



GK.1117



GK.1119

Etanj Tip Kablo Rakorları (Somunlu)

IP68

KOD	CİNSİ	KUTU	FİYAT
CR.2918	PG 7 Kablo Rakoru	400	3,40
CR.2919	PG 9 Kablo Rakoru	300	4,00
CR.2920	PG 11 Kablo Rakoru	200	5,00
CR.2921	PG 13,5 Kablo Rakoru	150	5,43
CR.2922	PG 16 Kablo Rakoru	125	6,70
CR.2923	PG 21 Kablo Rakoru	75	10,60
CR.2924	PG 29 Kablo Rakoru	30	19,35
CR.2925	PG 36 Kablo Rakoru	20	33,00
CR.2926	PG 42 Kablo Rakoru	15	40,65
CR.2927	PG 48 Kablo Rakoru	8	45,80



CR.2923



CR.2926

*Polyamid
*Halogen-Free, Alev Yaymaz

Plastik Sıra Klemensler

KOD	CİNSİ	KOLİ	KUTU	FİYAT
SK.3001	No.1 (2.5 - 4 mm ²)	1000	50	10,50
SK.3002	No.2 (4 - 6 mm ²)	1000	50	13,00
SK.3003	No.3 (6 - 10 mm ²)	600	50	16,50
SK.3004	No.4 (10 - 16 mm ²)	600	50	20,50
SK.3016	No.5 (16 - 25 mm ²)	500	50	24,80



SK.3001

Isiya Dayanıklı Sıra Klemensler

KOD	CİNSİ	KUTU	FİYAT	
SK.3005	No.1 (2.5 - 4 mm ²) Isiya Dayanıklı	1000	50	11,70
SK.3006	No.2 (4 - 6 mm ²) Isiya Dayanıklı	1000	50	14,40
SK.3007	No.3 (6 - 10 mm ²) Isiya Dayanıklı	600	50	18,30
SK.3008	No.4 (10 - 16 mm ²) Isiya Dayanıklı	600	50	22,50
SK.3017	No.5 (16 - 25 mm ²) Isiya Dayanıklı	500	50	26,70



SK.3005

Birinci Kalite Plastik Sıra Klemensler YANMAZ

KOD	CİNSİ	KOLİ	KUTU	FİYAT
SK.3106	No.1 (2.5 - 4 mm ²) Yanmaz	1000	50	13,00
SK.3107	No.2 (4 - 6 mm ²) Yanmaz	1000	50	17,00
SK.3108	No.3 (6 - 10 mm ²) Yanmaz	500	50	19,80
SK.3109	No.4 (10 - 16 mm ²) Yanmaz	500	50	24,00
SK.3110	No.5 (16 - 25 mm ²) Yanmaz	500	50	29,00



SK.3106

U Klemensler

KOD	CİNSİ	KUTU	FİYAT
İ.57020	6 mm. U Klemens	150	9,90
İ.57021	10 mm. U Klemens	125	13,70
İ.57022	16 mm. U Klemens	100	20,80
İ.57023	25 mm. U Klemens	100	24,00
İ.57024	35 mm. U Klemens	75	29,00
İ.57025	50 mm. U Klemens	50	46,25
İ.57026	70 mm. U Klemens	40	56,60
İ.57027	95 mm. U Klemens	25	73,50
İ.57028	120 mm. U Klemens	20	92,50
İ.57029	150 mm. U Klemens	15	132,00



Tırnaklı Klemensler

KOD	CİNSİ	KUTU	FİYAT
İ.57040	No.1 Tırnaklı Klemens (16 mm ²)	150	21,50
İ.57041	No.2 Tırnaklı Klemens (25 mm ²)	100	22,50
İ.57042	No.3 Tırnaklı Klemens (35 mm ²)	100	35,40
İ.57043	No.4 Tırnaklı Klemens (50 mm ²)	50	44,00
İ.57044	No.5 Tırnaklı Klemens (70 mm ²)	50	76,00
İ.57045	No.6-7 Tırnaklı Klemens (95 mm ²)	25	126,00



Porselen Sıra Klemensler

KOD	CİNSİ	KUTU	FİYAT
SK.3009	No.1 1'li Porselen Sıra Klemensler (6 mm ²)	200	6,30
SK.3010	No.1 2'li Porselen Sıra Klemensler (6 mm ²)	100	7,20
SK.3011	No.1 3'lü Porselen Sıra Klemensler (6 mm ²)	100	8,00
SK.3012	No.2 2'li Porselen Sıra Klemensler (10 mm ²)	100	8,00
SK.3013	No.2 3'lü Porselen Sıra Klemensler (10 mm ²)	100	10,75
SK.3014	No.3 2'li Porselen Sıra Klemensler (16 mm ²)	100	10,75
SK.3015	No.3 3'lü Porselen Sıra Klemensler (16 mm ²)	100	13,90



SK.3010

SK.3011

Buat İçi Yaylı Klemens (1.0-2.5 mm²) - ALEV İLETMEZ



KOD	CİNSİ	PAKET	FİYAT
BK.1951	2 Kutuplu Buat İçi Klemens (1-2,5mm)	1000	1,80
BK.1952	3 Kutuplu Buat İçi Klemens (1-2,5mm)	1000	2,10
BK.1953	4 Kutuplu Buat İçi Klemens (1-2,5mm)	500	2,50
BK.1954	5 Kutuplu Buat İçi Klemens (1-2,5mm)	500	2,70
BK.1955	8 Kutuplu Buat İçi Klemens (1-2,5mm)	250	4,35
BK.1957	Zeytin Klemens	500	0,36



Kompakt Çok Amaçlı Klemens (0.2-4 mm²)

KOD	CİNSİ	PAKET	FİYAT
BK.1972	2 x 4 mm Çok Amaçlı Klemens	100	3,75
BK.1973	3 x 4 mm Çok Amaçlı Klemens	100	4,95
BK.1974	4 x 4 mm Çok Amaçlı Klemens	50	6,20
BK.1975	5 x 4 mm Çok Amaçlı Klemens	50	7,25



Soket Klemens

KOD	CİNSİ	PAKET	FİYAT
BK.1980	Soket Klemens S/B	50	2,25 \$
BK.1981	Soket Klemens S/B Muhafazalı	50	3,05 \$



Vidalı Buat Klemensleri

KOD	CİNSİ	PAKET	FİYAT
BK.1962	No:2 Vidalı Buat Klemensi (6-10 mm ²)	364	1,40
BK.1963	No:3 Vidalı Buat Klemensi (10-16 mm ²)	240	2,00
BK.1964	No:4 Vidalı Buat Klemensi (16-25 mm ²)	130	2,50
BK.1965	No:5 Vidalı Buat Klemensi (25-50 mm ²)	80	3,40



WAGO Buat Klemensleri (1.0-2.5 mm²) - ALEV İLETMEZ



KOD	CİNSİ	PAKET	FİYAT
WAGO.2273-202	2 Kutuplu Buat İçi Klemens	100	0,177 €
WAGO.2273-203	3 Kutuplu Buat İçi Klemens	100	0,194 €
WAGO.2273-204	4 Kutuplu Buat İçi Klemens	100	0,243 €
WAGO.2273-205	5 Kutuplu Buat İçi Klemens	100	0,265 €
WAGO.773-106	6 Kutuplu Buat İçi Klemens	50	0,530 €
WAGO.2273-208	8 Kutuplu Buat İçi Klemens	50	0,473 €



WAGO Kompakt Çok Amaçlı Klemens (0.2-4 mm²)

KOD	CİNSİ	PAKET	FİYAT
WAGO.221-412	2 x 4 mm Çok Amaçlı Klemens	100	0,432 €
WAGO.221-413	3 x 4 mm Çok Amaçlı Klemens	50	0,532 €
WAGO.221-415	5 x 4 mm Çok Amaçlı Klemens	25	0,863 €
WAGO.221-2411	İki Taraflı Konnektör	60	0,557 €
WAGO.221-500	Ray Montaj Adaptörü	50	1,022 €



WAGO Aydınlatma Konnektörleri

KOD	CİNSİ	PAKET	FİYAT
WAGO.224-101	2.5mm Tek Girişli Konnektör	100	0,300 €
WAGO.224-112	2.5mm Çift Girişli Konnektör	100	0,350 €
WAGO.224-201	2.5mm İki Taraflı Yaylı Konnektör	50	0,810 €



1 Kutuplu Dağıtım Ünitesi Kapaklı (7x12 mm. 125A.)

KOD	CİNSİ	KUTU	FİYAT
SK.3060	2+5 Delikli Dağıtım Ünitesi	75	38,00
SK.3061	2+8 Delikli Dağıtım Ünitesi	60	44,90
SK.3062	2+10 Delikli Dağıtım Ünitesi	55	53,70
SK.3063	2+13 Delikli Dağıtım Ünitesi	35	60,00
SK.3064	2+18 Delikli Dağıtım Ünitesi	35	84,50



2 Kutuplu Dağıtım Ünitesi Kapaklı (7x12 mm. 125A.)

KOD	CİNSİ	KUTU	FİYAT
SK.3035	2+5 Delikli Dağıtım Ünitesi	22	78,80
SK.3036	2+8 Delikli Dağıtım Ünitesi	15	88,50
SK.3037	2+10 Delikli Dağıtım Ünitesi	14	99,00
SK.3038	2+13 Delikli Dağıtım Ünitesi	12	128,00
SK.3039	2+18 Delikli Dağıtım Ünitesi	6	164,00
SK.3034	2+20 Delikli Dağıtım Ünitesi	6	178,00



4 Kutuplu Dağıtım Ünitesi Kapaklı (7x12 mm. 125A.)

KOD	CİNSİ	KUTU	FİYAT
SK.3040	2+5 Delikli Dağıtım Ünitesi	10	158,00
SK.3041	2+8 Delikli Dağıtım Ünitesi	8	168,50
SK.3042	2+10 Delikli Dağıtım Ünitesi	6	192,40
SK.3043	2+13 Delikli Dağıtım Ünitesi	5	234,70
SK.3044	2+18 Delikli Dağıtım Ünitesi	4	308,00
SK.3045	2+20 Delikli Dağıtım Ünitesi	4	330,00
SK.3046	2+23 Delikli Dağıtım Ünitesi	4	384,00



4 Kutuplu Dağıtım Ünitesi Kapaklı (10x15 Kesit 160A.)

KOD	CİNSİ	KUTU	FİYAT
SK.3080	2+5 Delikli Dağıtım Ünitesi	12	292,00
SK.3081	2+8 Delikli Dağıtım Ünitesi	8	451,00
SK.3082	2+10 Delikli Dağıtım Ünitesi	8	504,00
SK.3083	2+13 Delikli Dağıtım Ünitesi	6	623,80
SK.3084	2+20 Delikli Dağıtım Ünitesi	4	848,00



5 Kutuplu Dağıtım Ünitesi Kapaklı (10x15 Kesit 160A.)

KOD	CİNSİ	KUTU	FİYAT
SK.3090	2+5 Delikli Dağıtım Ünitesi	8	351,00
SK.3091	2+8 Delikli Dağıtım Ünitesi	4	506,50
SK.3092	2+10 Delikli Dağıtım Ünitesi	4	600,60
SK.3093	2+13 Delikli Dağıtım Ünitesi	4	750,40
SK.3094	2+20 Delikli Dağıtım Ünitesi	3	1.080,00



Topraklama Klemensleri (6x8mm. Kesit)

KOD	CİNSİ		KUTU	FİYAT
SK.3020	4 Delikli	Topraklama Klemensi	1500	7,26
SK.3021	5 Delikli	Topraklama Klemensi	1500	7,68
SK.3022	6 Delikli	Topraklama Klemensi	1250	10,30
SK.3023	7 Delikli	Topraklama Klemensi	1000	10,80
SK.3024	9 Delikli	Topraklama Klemensi	1000	12,10
SK.3025	10 Delikli	Topraklama Klemensi	750	13,00
SK.3026	12 Delikli	Topraklama Klemensi	750	15,90

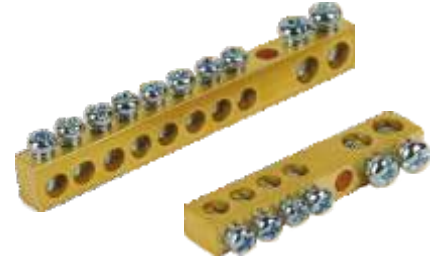

Ayaklı Topraklama Klemensleri (6,5x9mm. Kesit)

KOD	CİNSİ		KUTU	FİYAT
SK.3030	6 Delikli	Topraklama Klemensi	200	16,86
SK.3031	10 Delikli	Topraklama Klemensi	150	23,00
SK.3032	15 Delikli	Topraklama Klemensi	125	29,80
SK.3033	20 Delikli	Topraklama Klemensi	100	39,20

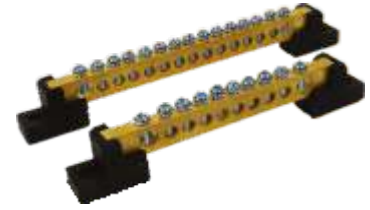

Bakır Nötr Toprak Eş Potansiyel Bara 250A. 4x20

KOD	CİNSİ	L	B	H	KUTU	FİYAT
SK.3208	1 Giriş 7 Çıkış	220	40	39	100	170,60
SK.3211	1 Giriş 10 Çıkış	270	40	39	75	212,80
SK.3215	1 Giriş 14 Çıkış	345	40	39	50	264,70



Bakır Kaplı Topraklama Çubuğu 250 Micron

KOD	CİNSİ		ADET	FİYAT	
B.53160	16 mm	1 mt	Topraklama Çubuğu	10	176,50
B.53161	16 mm	1,5 mt	Topraklama Çubuğu	10	263,50
B.53200	20 mm	1 mt	Topraklama Çubuğu	5	258,00
B.53201	20 mm	1,5 mt	Topraklama Çubuğu	5	372,50



W. Otomat Bara & Rayları

KOD	CİNSİ		KUTU	FİYAT
B.52942	MONOFAZE 1mm.	W.Otomat Barası 53 cm.	50	70,00
B.52962	MONOFAZE 1mm.	W.Otomat Barası 106 cm.	50	140,00
B.52940	TRİFAZE 1mm.	W.Otomat Barası 53 cm.	25	175,00
B.52960	TRİFAZE 1mm.	W.Otomat Barası 106 cm.	25	350,00
B.52944	15x1,5 mm.	Nötr Topraklama Barası 31 Pabuç	20	220,00
B.52902	W. Otomat Rayı	30 cm.	40	9,00
B.52901	W. Otomat Rayı	1 mt.	50	24,50

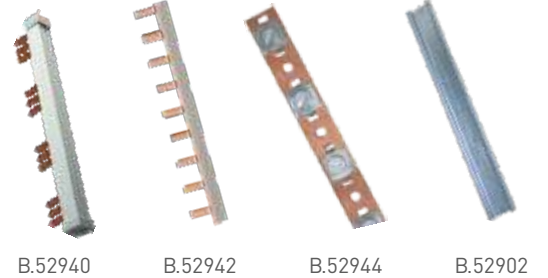

Mini İzolatörler

KOD	CİNSİ	KUTU	FİYAT
İ.57219	M5 Mini İzolatör İTC	250	4,80
İ.57220	M5 Mini İzolatör 1C + 1S	250	5,75
İ.57221	M5 Mini İzolatör İTS	250	6,75



İ.57219



İ.57220



İ.57221

Orta Boy Konik İzolatörler

KOD	CİNSİ	KUTU	FİYAT
İ.57225	M 6 Konik İzolatör İTC	100	9,00
İ.57226	M 6 Konik İzolatör 1C+1S	100	9,50
İ.57227	M 6 Konik İzolatör İTS	100	10,50
İ.57236	M 8 Fıçı İzolatör İTC 35 mm	50	13,90
İ.57237	M 8 Fıçı İzolatör 1C+1S 35 mm	50	13,90
İ.57238	M 8 Fıçı İzolatör İTS 35 mm	50	11,85



İ.57225



İ.57226



İ.57227

Büyük Boy Fıçı İzolatörler

KOD	CİNSİ	KUTU	FİYAT
İ.57228	M 8 İzolatör İTC 40 mm	50	17,40
İ.57232	M 8 İzolatör 1C+1S 40 mm	50	18,00
İ.57230	M 8 İzolatör İTS 40 mm	50	17,00
İ.57229	M 10 Fıçı İzolatör İTC	40	24,35
İ.57233	M 10 Fıçı İzolatör 1C+1S	40	23,20
İ.57231	M 10 Fıçı İzolatör İTS	40	23,10



İ.57229



İ.57233



İ.57231

Tarak İzolatörler

KOD	CİNSİ	KUTU	FİYAT
İ.57244	3 x 1 Tarak İzolatör (Kısa Tip)	40	21,50
İ.57245	3 x 1 F Tarak İzolatör	40	33,00
İ.57246	3 x 2 F Tarak İzolatör	40	33,75
İ.57247	3 x 1 F+N Tarak İzolatör	40	34,60
İ.57248	3 x 2 F+N Tarak İzolatör	8	48,70
İ.57240	Bara Tutucu Serfili (M 8 - M 10)	100	17,40



İ.57245



İ.57240

1N-500 İzolatör

KOD	CİNSİ	KUTU	FİYAT
İ.57250	M 10 1N-500 İzolatör	20	33,35
İ.57251	M 12 1N-500İzolatör	20	40,80



İ.57250



İ.57251

Ray Klemens Vidalı

KOD	CİNSİ	RENK	KUTU	KOLİ	FİYAT
RKV.151025	2,5 mm ²	● ● ● ● ● ●	60	2040	0,48 \$
RKV.151040	4 mm ²	● ● ● ● ● ●	50	1700	0,59 \$
RKV.151060	6 mm ²	● ● ● ● ● ●	40	1200	0,95 \$
RKV.151100	10 mm ²	●	30	1020	1,38 \$
RKV.151160	16 mm ²	●	50	850	1,80 \$
RKV.151250	25 mm ²	●	32	544	2,70 \$
RKV.151350	35 mm ²	●	28	476	3,36 \$



Topraklama Klemens Vidalı

KOD	CİNSİ	RENK	KUTU	KOLİ	FİYAT
RTV.152025	2,5 mm ²	●	60	1800	2,32 \$
RTV.152040	4 mm ²	●	50	1700	2,62 \$
RTV.152060	6 mm ²	●	40	1200	3,02 \$
RTV.152100	10 mm ²	●	30	1020	3,27 \$



Klemens Kapağı

KOD	CİNSİ	KUTU	FİYAT
RKK.101	Vidalı 4-10 mm ²	100	0,30 \$
RKK.102	Vidalı 16 mm ²	100	0,35 \$



Ray Klemens Yay baskılı

KOD	CİNSİ	RENK	KUTU	KOLİ	FİYAT
RKY.153025	2,5 mm ²	● ● ● ● ● ●	100	2100	0,54 \$
RKY.153040	4 mm ²	● ● ● ● ● ●	75	1575	0,84 \$
RKY.153060	6 mm ²	● ● ● ● ● ●	45	945	1,27 \$
RKY.153100	10 mm ²	●	25	550	2,12 \$



Topraklama Klemens Yay Baskılı

KOD	CİNSİ	RENK	KUTU	KOLİ	FİYAT
RKY.154025	2,5 mm ²	●	60	1800	1,97 \$
RKY.154040	4 mm ²	●	50	1700	2,60 \$
RKY.154060	6 mm ²	●	40	1200	3,33 \$



Klemens Kapağı Yaylı İçin

KOD	CİNSİ	KUTU	FİYAT
RKK.201	Yaylı 2,5 mm ² için	100	0,32 \$
RKK.202	Yaylı 4 mm ² için	100	0,34 \$
RKK.203	Yaylı 6 mm ² için	100	0,36 \$



Durdurucu

KOD	CİNSİ	KUTU	KOLİ	FİYAT
RKD.301	Vidalı	100	2000	0,41 \$
RKD.302	Yaylı	100	1600	0,67 \$



İzoleli Tek Girişli Yüksük

KOD	CİNSİ	KUTU	FİYAT
İTG.10005	İzoleli Tek Giriş Yüksük 0,50 mm	1000	0,122
İTG.10007	İzoleli Tek Giriş Yüksük 0,75 mm	1000	0,122
İTG.10010	İzoleli Tek Giriş Yüksük 1,00 mm	1000	0,122
İTG.10015	İzoleli Tek Giriş Yüksük 1,50 mm	1000	0,133
İTG.10025	İzoleli Tek Giriş Yüksük 2,50 mm	500	0,173
İTG.10040	İzoleli Tek Giriş Yüksük 4,00 mm	500	0,286
İTG.10060	İzoleli Tek Giriş Yüksük 6,00 mm	250	0,385
İTG.10100	İzoleli Tek Giriş Yüksük 10,00 mm	100	0,486
İTG.10160	İzoleli Tek Giriş Yüksük 16,00 mm	100	0,695
İTG.10250	İzoleli Tek Giriş Yüksük 25,00 mm	50	1,190
İTG.10350	İzoleli Tek Giriş Yüksük 35,00 mm	50	1,440
İTG.10500	İzoleli Tek Giriş Yüksük 50,00 mm	25	2,780



İzoleli Çift Girişli Yüksük

KOD	CİNSİ	KUTU	FİYAT
İÇG.11005	İzoleli Çift Giriş Yüksük 2x0,50 mm	1000	0,225
İÇG.11007	İzoleli Çift Giriş Yüksük 2x0,75 mm	500	0,230
İÇG.11010	İzoleli Çift Giriş Yüksük 2x1,00 mm	500	0,243
İÇG.11015	İzoleli Çift Giriş Yüksük 2x1,50 mm	500	0,295
İÇG.11025	İzoleli Çift Giriş Yüksük 2x2,50 mm	250	0,480
İÇG.11040	İzoleli Çift Giriş Yüksük 2x4,00 mm	200	0,560
İÇG.11060	İzoleli Çift Giriş Yüksük 2x6,00 mm	100	0,695



İzoleli Yuvarlak Tip Papuç

KOD	CİNSİ	KUTU	FİYAT
İYT.120154	İzoleli Yuvarlak Tip Papuç 0,5-1,5 mm (M4)	200	0,560
İYT.120155	İzoleli Yuvarlak Tip Papuç 0,5-1,5 mm (M5)	200	0,580
İYT.120156	İzoleli Yuvarlak Tip Papuç 0,5-1,5 mm (M6)	200	0,900
İYT.120158	İzoleli Yuvarlak Tip Papuç 0,5-1,5 mm (M8)	200	0,905
İYT.120254	İzoleli Yuvarlak Tip Papuç 1,5-2,5 mm (M4)	200	0,700
İYT.120255	İzoleli Yuvarlak Tip Papuç 1,5-2,5 mm (M5)	200	0,720
İYT.120256	İzoleli Yuvarlak Tip Papuç 1,5-2,5 mm (M6)	200	1,020
İYT.120258	İzoleli Yuvarlak Tip Papuç 1,5-2,5 mm (M8)	200	1,020
İYT.120604	İzoleli Yuvarlak Tip Papuç 4-6 mm (M4)	100	1,490
İYT.120605	İzoleli Yuvarlak Tip Papuç 4-6 mm (M5)	100	1,490
İYT.120606	İzoleli Yuvarlak Tip Papuç 4-6 mm (M6)	100	1,660
İYT.120608	İzoleli Yuvarlak Tip Papuç 4-6 mm (M8)	100	2,140



İzoleli Çatal Tip Papuç

KOD	CİNSİ	KUTU	FİYAT
İÇT.130154	İzoleli Çatal Tip Papuç 0,5-1,5 mm (M4)	200	0,535
İÇT.130155	İzoleli Çatal Tip Papuç 0,5-1,5 mm (M5)	200	0,550
İÇT.130156	İzoleli Çatal Tip Papuç 0,5-1,5 mm (M6)	200	0,620
İÇT.130254	İzoleli Çatal Tip Papuç 1,5-2,5 mm (M4)	200	0,585
İÇT.130255	İzoleli Çatal Tip Papuç 1,5-2,5 mm (M5)	200	0,590
İÇT.130256	İzoleli Çatal Tip Papuç 1,5-2,5 mm (M6)	200	0,790
İÇT.130604	İzoleli Çatal Tip Papuç 4-6 mm (M4)	100	1,300
İÇT.130605	İzoleli Çatal Tip Papuç 4-6 mm (M5)	100	1,320
İÇT.130606	İzoleli Çatal Tip Papuç 4-6 mm (M6)	100	1,770



Bakır Kablo Pabuçları (Ekonomik Tip)

KOD	CİNSİ			KUTU	FİYAT
CP3100	6 mm	Kablo Pabucu	M5	1000	3,10
CP3101	10 mm	Kablo Pabucu	M6	500	3,20
CP3102	16 mm	Kablo Pabucu	M6	500	3,35
CP3103	25 mm	Kablo Pabucu	M8	400	6,70
CP3104	35 mm	Kablo Pabucu	M8	250	9,70
CP3105	50 mm	Kablo Pabucu	M10	200	12,20
CP3106	70 mm	Kablo Pabucu	M10	125	19,20
CP3107	95 mm	Kablo Pabucu	M12	100	22,30
CP3108	120 mm	Kablo Pabucu	M12	70	31,50
CP3109	150 mm	Kablo Pabucu	M12	50	50,50
CP3110	185 mm	Kablo Pabucu	M16	30	60,90
CP3111	240 mm	Kablo Pabucu	M16	25	92,80



Bakır Kablo Pabuçları (Standart Tip)

KOD	CİNSİ			KUTU	FİYAT
CP3100-1	6 mm	Kablo Pabucu	M5	500	3,70
CP3101-1	10 mm	Kablo Pabucu	M6	500	4,00
CP3102-1	16 mm	Kablo Pabucu	M6	500	6,00
CP3103-1	25 mm	Kablo Pabucu	M8	300	10,10
CP3104-1	35 mm	Kablo Pabucu	M8	200	13,70
CP3105-1	50 mm	Kablo Pabucu	M10	125	20,00
CP3106-1	70 mm	Kablo Pabucu	M10	100	26,30
CP3107-1	95 mm	Kablo Pabucu	M12	70	33,00
CP3108-1	120 mm	Kablo Pabucu	M12	60	46,00
CP3109-1	150 mm	Kablo Pabucu	M12	50	71,00
CP3110-1	185 mm	Kablo Pabucu	M12	30	88,50
CP3111-1	240 mm	Kablo Pabucu	M16	25	120,00
CP3112-1	300 mm	Kablo Pabucu	M16	10	145,00



Bakır Sıkmalı Ek Muflar

KOD	CİNSİ			KUTU	FİYAT
CP3121	6 mm	Ek Muf		1000	4,70
CP3122	10 mm	Ek Muf		1000	4,90
CP3123	16 mm	Ek Muf		500	4,90
CP3124	25 mm	Ek Muf		400	8,25
CP3125	35 mm	Ek Muf		250	11,55
CP3126	50 mm	Ek Muf		200	14,40
CP3127	70 mm	Ek Muf		125	23,55
CP3128	95 mm	Ek Muf		100	26,50
CP3129	120 mm	Ek Muf		70	38,25
CP3130	150 mm	Ek Muf		50	59,30
CP3131	185 mm	Ek Muf		30	74,00
CP3132	240 mm	Ek Muf		25	113,00



Mekanik & Hidrolik Pabuç Sıkma Penseleri

KOD	CİNSİ			KUTU	FİYAT
CP3140	6 - 50	Mekanik Pabuç Sıkma Pensesi		1	76,00 \$
CP3141	10 - 120	Mekanik Pabuç Sıkma Pensesi		1	153,00 \$
CP3150	10 - 120	Hidrolik Pabuç Sıkma Pensesi		1	140,00 \$
CP3151	16 - 300	Hidrolik Pabuç Sıkma Pensesi		1	150,00 \$



CP3141

CP3150

Kapı & Merdiven Işık Otomatikleri

KOD	CİNSİ	KOLİ	FİYAT
ÇPM.1956	Merdiven Işık Otomatigi (Raylı)	30	166,00
ÇPM.1958	Merdiven Işık Otomatigi	30	166,00
ÇPM.1961	Zincirli Kapı Otomatigi	30	182,00
ÇPM.1962	Zincirli Kapı Otomatigi Butonlu	30	182,00
ÇPM.1963	Kilitli Kapı Otomatigi	12	428,00
ÇPM.1965	Dokunmatik Gizli Kapı Otomatigi	20	219,00
ÇPM.1966	Basmatik Gizli Kapı Otomatigi	20	219,00
ÇPM.1967	Akıllı Kapı Kiliti	12	960,00
ÇPM.1957	Bas Aç (Trajlı) Kilit İçin	20	268,00



Sinyal Lambaları

KOD	CİNSİ	KUTU	FİYAT
SL.1885	10 mm. Sinyal Lambası Kablolu	50	5,40
SL.1884	14 mm. Sinyal Lambası	50	9,40
SL.1881	22 mm. Sinyal Lambası	20	10,00
SL.1886	22 mm. Sinyal Lambası Ledli	10	13,55



Şalterler

KOD	CİNSİ	KUTU	FİYAT
SL.1888	Monofaze Şalter 250 V 25 A	100	62,00
SL.1889	Trifaze Şalter 380 V 25 A	50	96,00



Butonlar

KOD	CİNSİ	KUTU	FİYAT
SL.1882	Kumanda Start Butonu 4 Kontaklı	10	23,40
SL.1883	Kumanda Stop Butonu 4 Kontaklı	10	23,40
SL.1871	22mm Mantar Start Butonu	10	29,25
SL.1872	22mm Mantar Stop Butonu	10	29,25
SL.1873	22mm Kilitlemeli Start Butonu	10	38,60
SL.1874	22mm Kilitlemeli Stop Butonu	10	38,60
SL.1875	Mandallı Kalıcı Buton (0-1)	10	29,25



Kutulu Acil Stop Butonu

KOD	CİNSİ	KUTU	FİYAT
SL.1887	Kutulu Acil Stop Butonu	10	80,00



Buton Kutuları

KOD	CİNSİ	KUTU	FİYAT
BT3-1000-0002	Tekli Buton Kutusu	16	31,45
BT3-2000-0002	İkili Buton Kutusu	12	45,00
BT3-3000-0002	Üçlü Buton Kutusu	8	54,00
BT3-4000-0002	Dörtlü Buton Kutusu	16	65,00
BT3-1020-0002	10 A. Pako Şalter Kutusu	16	41,90
BT3-2030-0002	25 A. Pako Şalter Kutusu	12	55,90
BT3-4050-0002	Prizli Sigorta Kutusu	16	125,70
BT3-4060-0002	Prizli Sinyalli Sigorta Kutusu	16	146,65



Zil Butonları

KOD	CİNSİ	KUTU	FİYAT
ZB.1285	Lüks Alüminyum Zil Butonu (1-12)	1	18,90
ZB.1283	Fantazi Zil Butonu Işıklı Ampullü	24	6,50
ZB.1286	Tekbir Zil Butonu	60	7,30
ZB.1287	Tekbir Zil Butonu Işıklı	60	11,70
ZB.1288	Tekbir Kare Zil Butonu	60	7,30
ZB.1289	Zil Düğmesi	50	6,50



ZB.1285



ZB.1286



ZB.1287



ZB.1288



ZB.1289



ZB.1283

Dekoratif Zil Butonları

KOD	CİNSİ	KUTU	FİYAT
ZB.137	Aslanbaş Döküm Işıklı	1	156,00
ZB.138	Venüs Döküm	1	136,00
ZB.139	Aslanbaş Dikdörtgen	1	136,00
ZB.140	Taç Döküm Büyük	1	130,00
ZB.141	Taç Döküm Küçük	1	123,00
ZB.142	Efes Döküm Büyük	1	130,00
ZB.143	Efes Döküm Küçük	1	123,00
ZB.144	Oval Döküm Küçük	1	123,00
ZB.132	Ahşap Fantazi Zil Butonu	1	162,00
ZB.133	Ahşap Yuvarlak Zil Butonu	1	162,00
ZB.151	Yuvarlak Mermer Zil Butonu	1	175,00



ZB.137



ZB.138



ZB.139



ZB.140



ZB.141



ZB.142



ZB.143



ZB.144



ZB.132



ZB.133



ZB.151

Zil Çeşitleri

KOD	CİNSİ	KUTU	FİYAT
Z.2180	Tek Ses Kanarya	90	38,00
Z.2181	Melodili Zil	50	66,00
Z.2182	4 Sesli Ayarlı Ding Dong Zil	65	42,00
Z.2183	Ayarlı Telefon Zili	50	78,00
Z.2184	Uzaktan Kumandalı Zil	60	138,00
Z.2185	Duafon Şube	50	83,00



ZB.2182



ZB.2184

Zil Trafoları

KOD	CİNSİ	KUTU	FİYAT
ÇPM.1971	4 - 8 - 12 W. Zil Trafosu	45	92,50
ÇPM.1972	15 x 15 Zil Trafosu	30	103,00
ÇPM.1973	15 x 24 Zil Trafosu	30	110,00



ÇPM.1971



ÇPM.1972

Fişler

KOD	CİNSİ	PAKET	FİYAT
FP1813	Duy Fiş	50	6,40
FP1818	Erkek Fiş	50	6,90
FP1819	Dişi Fiş	50	6,90
FP1820	Topraklı Erkek Fiş Düz	50	8,75
FP1834	L Tipi UPS Topraklı Fiş	40	16,00
FP10024	Topraklı Dişi Fiş	50	8,70
FP10023	Ara Puar	50	6,85
FP1810	Universal Fiş/Priz	50	16,00
FP1811	Amerikan Fiş	50	6,20
FP1812	İngiliz Fiş	50	9,85
FP1815	3'lü Golyat Topraklı Fiş Priz	24	23,00
A.10026	Prizmatik - Çocuk Koruma (Yapışkanlı)	50	9,10



Grup Prizler Klemensli

KOD	CİNSİ	PAKET	FİYAT
FP4808	8'li Topraklı Grup Priz Klemensli	28	130,00
FP4812	12'li Topraklı Grup Priz Klemensli	24	175,00



Kontrol Kalemleri

KOD	CİNSİ	PAKET	FİYAT
AKB.6590	Kontrol Kalemi	12	11,00
AKB.6591	Kontrol Kalemi (Yıldız)	12	11,00
VT.6190	Kontrol Kalemi Vip-Tec	24	23,00
VT.6191	Kontrol Kalemi (Yıldız Uçlu) Vip-Tec	24	23,00
VT.6192	Cep Kontrol Kalemi Vip-Tec	24	23,00



Takım Çantaları VIP-TEC

KOD	CİNSİ	PAKET	FİYAT
VT.6000/71	Tornavida Takımı (7 Parça)	1	298,00
VT.210103	Pense Takımı (3 Parça)	1	674,00
VT.210309	Tornavida ve Pense Takımı (9 Parça)	1	790,00
VT.100130	Kapsamlı Set Takımı	1	880,00



VT.100130



VT.210309

Maket Bıçakları VIP-TEC

KOD	CİNSİ	PAKET	FİYAT
VT.875106	Maket Bıçağı (Döküm)	24	29,20
VT.875107	Maket Bıçağı (Plastik)	24	26,40
VT.875000	Maket Yedek Bıçağı (Kutusu)	10	27,80



VT.875106

Florasın Duylar

KOD	CİNSİ	PAKET	FİYAT
SMG.10-002	32 Watt Starter Yuvalı Duy	100	20,00
SMG.10-001	32 Watt Simit K�p Duy	100	20,00
FD.01406	Simit Ay Ayak	250	0,37
FD.01402	Vidalı Ay Ayak	100	0,58
FD.0407	Starter Yuvası (Vidalı)	100	5,40
SMG.313-002	Reklam Starter Yuvası	100	4,25
SMG.13-005	TMS Duy Tekli Plastik Tırnaklı	50	9,75
SMG.213-001	TMS Duy iftli Plastik Tırnaklı	50	20,00
SMG.5-005	G 5 Reklam Duy (T5 iin)	100	6,25
SMG.5-003	Dekoratif Kısa Ayak (T5 iin)	100	4,85
SMG.100-004	Metal Ampul Tutucu (T5 iin)	100	3,50
SMG.13-014	G 13 Reklam Duy (T8 iin)	100	8,25
SMG.13-015	G 13 Reklam Duy Starter Yuvalı (T8 iin)	50	9,40
SMG.13-008	G 13 Tekli Etanj Duy (T8 iin)	50	8,75
SMG.13-010	G 13 Tekli Etanj Duy Yaylı (T8 iin)	50	7,80
SMG.13-019	G 13 Parabolik Armat�r Duy (T8 iin)	100	5,65
SMG.13-019Y	G 13 Parabolik Arm. Duy Yaylı (T8 iin)	100	6,85
SMG.100-003	Metal Ampul Tutucu (T8 iin)	100	4,00
SMG.13-012	Dekoratif Kısa Ayak (T8 iin)	100	7,25
FZ.1925	Florasın Zinciri	100	5,30



Duylar

KOD	CİNSİ	PAKET	FİYAT
FP1822	Duy Priz	50	18,00
FP01829	Yağmur Duy	50	8,60
FP1830	E-14 Bronz Duy	100	18,20
FP1831	E-27 Bronz Duy	50	19,90
FP1801	E-14 İtalyan Duy	100	7,75
FP1803	E-27 İtalyan Duy	50	8,20
FP1800	Asma Duy	50	5,05
PA.1804	E-27 Porselen Duy	400	4,10
PA.1824	Muhafazalı Askı Tij Takımı Porselen Duylu	50	8,85
PA.1805	Tavan Duy	40	6,00
PA.1806	Duvar Duy	40	6,00
PA.1807	Tavan Glop Dibi	24	6,75
PA.1808	Duvar Glop Dibi	24	6,75
PM.1960	Minyonet Duy	100	1,70
PA.1802	Pil Yatağı	100	5,20
PM.1974	ıt-ıt Anahtar	100	5,30
PM.1975	Deney Seti	25	20,80
PA.1824-1	Muhafazalı Askı Tij Takımı Plastik Duylu	50	6,90



İkaz Kornaları - İkaz İhbar Butonları

KOD	CİNSİ	KUTU	FİYAT
SE.1001 A	İkaz Korna Plastik 220 V.	30	208,00
SE.1001 C	İkaz Korna Plastik 24 V.	30	255,00
SE.1002 A	İkaz Korna Döküm 220 V.	20	298,00
SE.1016	Kare İkaz İhbar Butonu	50	89,50
SE.1016 Ç	Kare İkaz İhbar Butonu Çekiçli	40	149,00
ES.220	Elektronik Siren 220 V.	100	255,00
ESL.220	Elektronik Siren Ledli 220 V.	100	420,00
SE.1018	Resetlenebilir İkaz Butonu 220	50	239,50
SE.2001-S1	Motorlu Siren 220 V. - 150 W.	1	1.425,00
SE.2003-S2	Motorlu Siren 220 V. - 200 W.	1	1.575,00
SE.1010	Kampana Zil (Okul Çanı) 220	24	480,00
SE.1010-24	Kampana Zil (Okul Çanı) 24 V.	24	528,00
SE.2022	Pla Zil 4 - 8 - 12 V.	72	240,00
SE.2023	Kloş Zil 4 - 8 - 12 V.	56	256,00
SE.1004	Seyyar El Lambası (Duysuz)	30	135,00
SE.1004 A	Seyyar El Lambası Anahtarlı	30	195,00



SE.1001 A



SE.1002 A



SE.1016



ES.220



ESL.220



SE.1018



SE.1004/A



SE.1004



SE.2001-S1



SE.2022



SE.1010

Sirenler - Dedektörler

KOD	CİNSİ	KUTU	FİYAT
EOD.1030	Optik Duman Dedektörü - Soketli	1	28,00 \$
EHD.1030	-Sabit Sıcaklık Dedektörü - Soketli	1	23,90 \$
ECP1004	4 Zonlu Yangın Alarm Kontrol Paneli	1	270,00 \$
ECP1008	8 Zonlu Yangın Alarm Kontrol Paneli	1	301,50 \$
ECP1012	12 Zonlu Yangın Alarm Kontrol Paneli	1	343,00 \$
BAT.1270	12 V./7 Ah Kuru Tip Akü	1	41,50 \$
SE.1017	İhbar Butonu 24 V.	1	12,75 \$
ES.24	Elektronik Siren 24 V.	1	13,65 \$
ESL.24	Elektronik Siren Ledli 24 V.	1	23,65 \$
EGD.24	LPG ve Gaz Dedektörü	1	41,60 \$
DD.2021	Pilli Duman Dedektörü (85 Desibel)	1	18,75 \$



EHD.1030



EOD.1030



DD.2021



EGD.24



ECP1008



BAT.1270



ES.24



ESL.24



SE.1017



GA.1081

Ledli Acil EXIT-Çıkış
Koli Adedi: 20

195,00 TL



GA.1082

Ledli Acil EXIT-Çıkış Arm.
Koli Adedi: 20

195,00 TL



GA.1083

Ledli Acil EXIT-Çıkış Arm.
Koli Adedi: 20

195,00 TL



GA.1084

Ledli Acil EXIT-Çıkış Arm.
Koli Adedi: 20

195,00 TL

İkaz Kornaları

KOD	cinsi	KOLİ	FİYAT
YİS.100	220V İkaz Korna CE	45	147,80
YİS.101	220V Alarm Korna (Döküm)	30	174,00
YİS.102	220V Alarm Korna (Plastik)	30	156,00
YİS.103	220V Alarm Korna Plastik CE	30	208,00
YİS.104	220V Alarm Korna Metal CE	30	229,00
YİS.105	220V Ledli Elektronik Siren	30	208,00



YİS.100



YİS.105

Yangın İhbar Butonları

KOD	cinsi	ÇALIŞMA GERİLİMİ	KOLİ	FİYAT
YİS.201	İkaz Butonu (Kare) CE	12V-24V-220V	90	46,75
YİS.202	İkaz Butonu (Yuvarlak)	12V-24V-220V	100	46,75
YİS.203	Resetlenebilir Yangın Butonu CE	220V	90	195,00
YİS.204	Resetlenebilir Yangın Butonu (Kapaklı) CE	220V	90	210,00
YİS.205	Çekiçli Yangın İhbar Butonu (Döküm)	12V-24V-220V	1	650,00



YİS.201



YİS.204

İkaz Sirenleri

KOD	cinsi	KOLİ	FİYAT
YİS.301	220V Metal Kampana Zil CE	24	350,00
YİS.302	1 Numara Motorlu Siren Plastik CE	20	507,00
YİS.303	2 Numara Motorlu Siren Plastik CE	12	570,00
YİS.304	1 Numara Motorlu Siren Döküm CE	20	660,00
YİS.305	2 Numara Motorlu Siren Döküm CE	12	765,00



YİS.301



YİS.302



YİS.303

Tepe Lambaları (Ledli)

KOD	cinsi	KUTU	FİYAT
SE.1220-24	24V AC/DC	1	628,00
SE.1220-220	220V AC	1	628,00



Uçak İkaz Lambaları

KOD	cinsi	KUTU	FİYAT
SE.125	Uçak İkaz Lambası (Tabana Montaj)	1	163,00 \$
SE.126	Uçak İkaz Lambası (Tek Kollu)	1	163,00 \$



Acil Aydınlatma Armatürü

KOD	cinsi	KUTU	FİYAT
SE.001	2 x 3W Acil Aydınlatma Armatürü	10	685,00



Kapaklı Masa Üstü Priz Kutuları

KOD	CİNSİ	MONTAJ ÖLÇÜSÜ	FİYAT
CA.13305	5 Modül Kapaklı Masa Üstü Priz Kutusu	156 x 98	348,00
CA.13308	8 Modül Kapaklı Masa Üstü Priz Kutusu	225 x 98	458,00
CA.13310	10 Modül Kapaklı Masa Üstü Priz Kutusu	270 x 98	525,00
CA.13312	12 Modül Kapaklı Masa Üstü Priz Kutusu	315 x 98	593,00
CA.13316	16 Modül Kapaklı Masa Üstü Priz Kutusu	405 x 98	740,00



Gömme Tip Priz Kutuları

KOD	CİNSİ	MONTAJ ÖLÇÜSÜ	FİYAT
CA.13406	6 Modül Gömme Tip Priz Kutusu	140 x 59	290,00
CA.13408	8 Modül Gömme Tip Priz Kutusu	185 x 59	330,00
CA.13410	10 Modül Gömme Tip Priz Kutusu	230 x 59	373,00
CA.13412	12 Modül Gömme Tip Priz Kutusu	275 x 59	415,00
CA.13416	16 Modül Gömme Tip Priz Kutusu	365 x 59	490,00

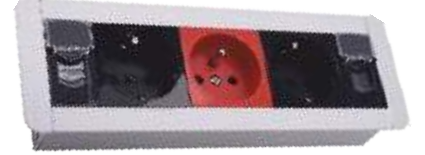

Tezgah Altı Priz Kutuları

KOD	CİNSİ	FİYAT
CA.13605	5 Modül Tezgah Altı Priz Kutusu	172,00
CA.13608	8 Modül Tezgah Altı Priz Kutusu	234,00
CA.13612	12 Modül Tezgah Altı Priz Kutusu	322,00
CA.13616	16 Modül Tezgah Altı Priz Kutusu	424,00



Prizli Usb Şarjlı Anahtarlı Led Aydınlatmalı Priz Blokları

KOD	CİNSİ	FİYAT
CA.13721	2 Şebeke Prizli USB Şarjlı Anahtarlı Led Aydınlatmalı Priz Bloğu (Inox)	1.600,00
CA.13731	3 Şebeke Prizli USB Şarjlı Anahtarlı Led Aydınlatmalı Priz Bloğu (Inox)	1.650,00
CA.13740	4 Şebeke Prizli Anahtarlı Led Aydınlatmalı Priz Bloğu (Inox)	920,00



Alüminyum Priz Kasası

KOD	CİNSİ	FİYAT
CA.10406	6 Modül Boş Alüminyum Bürotik Priz kasası	111,00
CA.10408	8 Modül Boş Alüminyum Bürotik Priz kasası	132,00
CA.10410	10 Modül Boş Alüminyum Bürotik Priz kasası	158,00
CA.10412	12 Modül Boş Alüminyum Bürotik Priz kasası	183,00
CA.10414	14 Modül Boş Alüminyum Bürotik Priz kasası	204,00
CA.10416	16 Modül Boş Alüminyum Bürotik Priz kasası	231,00
CA.10418	18 Modül Boş Alüminyum Bürotik Priz kasası	247,50
CA.10420	20 Modül Boş Alüminyum Bürotik Priz kasası	268,00



*Prizler montajsızdır.

**CA.10300**

36 x 36
Döşeme Altı Buat Sac
Koli Adedi: 5
370,00 TL

**CA.10301**

27 x 27 Priz Kasası
(18 Modül)
Koli Adedi: 10
356,00 TL

**CA.10305**

Döşeme Altı Buat (PIs) +
Priz Kutusu 354 x 354mm
Koli Adedi: 5
810,00 TL

**CA.10302**

120'lik Gromet
Döşeme Altı Priz Kutusu
Kutu Adedi: 34
Montaj Ölçüsü 120mm.
228,00 TL

**CA.10304**

120'lik Gromet
Masa Tipi Priz Kutusu
Kutu Adedi: 34
Montaj Ölçüsü 120mm.
210,00 TL

**CA.10306**

Döşeme Altı Gromet
8 Modül + 4 Keystone Jack
Kutu Adedi: 1
Montaj Ölçüsü 150x137mm.
256,00 TL

**CA.10307**

Masa Tipi Gromet
8 Modül + 4 Keystone Jack
Kutu Adedi: 1
Montaj Ölçüsü 150x137mm.
244,00 TL

Prizsiz

Silindir Priz Kutuları

KOD	CİNSİ	DELİK ÇAPI	FİYAT
CA.13806	6 Modül Silindir Priz Kutusu (Inox)	105	513,00
CA.13808	8 Modül Silindir Priz Kutusu (Inox)	105	559,50
CA.13810	10 Modül Silindir Priz Kutusu (Inox)	105	590,00

**Kablo Toplayıcılar**

KOD	CİNSİ	FİYAT
KTS.3200	Kablo Toplayıcı Omurga (Gri) 75 cm	215,00
KTS.3200-1	Kablo Toplayıcı Omurga (Siyah) 75 cm	215,00



Sıva Üstü Anahtar Grubu

KOD	CİNSİ	KUTU	KOLİ	FİYAT
N-95-01	Anahtar	12	120	27,80
N-95-33	3'lü Anahtar	12	120	39,80
N-95-03	Komitatör	12	120	32,65
N-95-14	Light Anahtar	12	120	32,50
N-95-04	Işıklı Light Anahtar	12	120	35,50
N-95-05	Vavien	12	120	32,50
N-95-52	Komitatör Vavien	12	120	39,80
N-95-13	Kapı Otomatiği Anahtarı	12	120	32,65
N-95-12	Zil Anahtarı	12	120	32,65
N-95-41	Jaluzi Kumanda Anahtarı	12	120	47,80
N-95-51	Permütatör (Ara Vavien)	12	120	41,65



Sıva Üstü Anahtar Priz Grubu

KOD	CİNSİ	KUTU	KOLİ	FİYAT
N-95-02	Normal Priz	12	120	28,95
N-95-08	Topraklı Priz	12	120	32,60
N-95-09	Kapaklı Topraklı Priz	12	120	36,90
N-95-08-E	Çocuk Korumalı Topraklı Priz	12	120	33,30
N-95-09-E	Çocuk Korumalı Kapaklı Topraklı Priz	12	120	38,10
N-95-15	UPS Priz	12	120	33,75



Sıva Üstü Data Priz Grubu

KOD	CİNSİ	KUTU	KOLİ	FİYAT
N-95-11-1	Tekli Numeris Telefon Prizi (Cat 3)	12	120	30,15
N-95-11-2	İkili Numeris Telefon Prizi (Cat 3 + Cat 3)	12	120	41,85
N-95-21-D1	Tekli Data Prizi (Cat 5)	12	120	77,90
N-95-21-D2	İkili Data Prizi (Cat 5 + Cat 5)	12	120	122,50
N-95-23-D1	Tekli Data Prizi (Cat 6)	12	120	80,30
N-95-23-D2	İkili Data Prizi (Cat 6 + Cat 6)	12	120	126,00
N-95-07	TV Anten Prizi (Geçişli - Sonlu)	12	120	40,65
N-95-25	Tekli Uydu Sat Priz (Geçişli - Sonlu)	12	120	73,80
N-95-27	Uydu Sat Priz Eko	12	120	35,10



Sıva Üstü İkili Priz Grubu

KOD	CİNSİ	KUTU	KOLİ	FİYAT
N-95-01-08	Anahtar + Topraklı Priz	5	50	63,31
N-95-03-08	Komitatör + Topraklı Priz	5	50	67,35
N-95-08-08	Topraklı Priz + Topraklı Priz	5	50	67,70
N-95-09-09	Kapaklı Topraklı Priz + Kapaklı Topraklı Priz	5	50	76,80
N-95-03-09	Komitatör + Kapaklı Topraklı Priz	5	50	71,00
N-95-03-03	Komitatör + Komitatör	5	50	64,35
N-95-01-09	Anahtar + Kapaklı Topraklı Priz	5	50	68,40
A.10026	Prizmatik - Çocuk Koruma (Yapışkanlı)	50	-	9,10



N-1003

3'lü Topraklı
Fiş / Priz
Kutu Adedi: 20

39,80 TL



N-1003-A

Sıva Altı
3'lü Topraklı Priz
Kutu Adedi: 20

52,30 TL



N-1001-A

Anahtarlı
Topraklı Priz
Kutu Adedi: 10

36,00 TL



N-1015-A

Anahtarlı Topraklı
Mobilya Priz
Kutu Adedi: 25

29,00 TL



N-93-110-85

İkili Topraklı Priz
(Monoblok)
Kutu Adedi: 6

50,00 TL

Aspiratörler

KOD	CİNSİ	KOLİ	FİYAT
EF1009	100'lük Aspiratör	24	304,00
EF1219	120'lik Aspiratör	20	324,00
EF1530	150'lik Aspiratör	16	395,00



Kapaklı Aspiratör

KOD	CİNSİ	KOLİ	FİYAT
BK.160	16'lik Kapaklı Aspiratör	8	720,00
BK.200	20'lik Kapaklı Aspiratör	8	829,00
BK.250	25'lik Kapaklı Aspiratör	8	1.025,00
BK.300	30'luk Kapaklı Aspiratör	8	1.150,00



Baca Tipi Aspiratör

KOD	CİNSİ	KOLİ	FİYAT
BB.160	16'lik Baca Tipi Aspiratör	8	648,00
BB.200	20'lik Baca Tipi Aspiratör	8	738,00
BB.250	25'lik Baca Tipi Aspiratör	8	845,00
BB.300	30'luk Baca Tipi Aspiratör	8	970,00



Sanayi Tipi Aspiratörler (Monofaze)

KOD	CİNSİ	KOLİ	FİYAT
BSM.250	25'lik Sanayi Tipi Aspiratör (Monofaze)	1	2.100,00
BSM.300	30'luk Sanayi Tipi Aspiratör (Monofaze)	1	2.260,00
BSM.350	35'lik Sanayi Tipi Aspiratör (Monofaze)	1	2.310,00
BSM.400	40'lik Sanayi Tipi Aspiratör (Monofaze)	1	2.430,00
BSM.450	45'lik Sanayi Tipi Aspiratör (Monofaze)	1	2.830,00
BSM.500	50'lik Sanayi Tipi Aspiratör (Monofaze)	1	2.950,00
BSM.550	55'lik Sanayi Tipi Aspiratör (Monofaze)	1	3.585,00
BSM.600	60'lik Sanayi Tipi Aspiratör (Monofaze)	1	3.655,00



Sanayi Tip Aspiratörler (Trifaze)

KOD	CİNSİ	KOLİ	FİYAT
BST.250	25'lik Sanayi Tipi Aspiratör (Trifaze)	1	2.100,00
BST.300	30'luk Sanayi Tipi Aspiratör (Trifaze)	1	2.260,00
BST.350	35'lik Sanayi Tipi Aspiratör (Trifaze)	1	2.310,00
BST.400	40'lik Sanayi Tipi Aspiratör (Trifaze)	1	2.430,00
BST.450	45'lik Sanayi Tipi Aspiratör (Trifaze)	1	2.830,00
BST.500	50'lik Sanayi Tipi Aspiratör (Trifaze)	1	2.950,00
BST.550	55'lik Sanayi Tipi Aspiratör (Trifaze)	1	3.585,00
BST.600	60'lik Sanayi Tipi Aspiratör (Trifaze)	1	3.655,00



Hız Kontrol Cihazları

KOD	CİNSİ	KOLİ	FİYAT
BSC.1	2A Hız Kontrol Cihazı	1	825,00
BSC.2	5A Hız Kontrol Cihazı	1	860,00





AIR.SUM

AIRCOL Summer
Koli Adedi: 6
595,00 TL



AIR.140-TS

AIRCOL Spring
Koli Adedi: 6
590,00 TL



AIR.140-TSL

AIRCOL Spring Light
Koli Adedi: 6
632,00 TL



AIR.250

AIRCOL 250 Silence
Koli Adedi: 6
786,00 TL



AIR.T Lüx

AIRCOL Lüx Silence
Koli Adedi: 6
835,00 TL



AIR.250F

AIRCOL 250F Silence
Koli Adedi: 6
1.010,00 TL



AIR.250T

AIRCOL 250T
Koli Adedi: 6
1.010,00 TL



AIR.150C MP

150C Mekanik Panjur
Koli Adedi: 6
432,00 TL



AIR.150C OP

150C Otomatik Panjur
Koli Adedi: 6
515,00 TL



AIR.MOP30

MOP 30/60
Koli Adedi: 6
540,00 TL

Sac Gövdeli Aksiyel Fanlar

KOD	CİNSİ	KOLİ	FİYAT
AIR.200-MS	200 MS Sac Gövdeli Aksiyel Fanlar	1	854,00
AIR.250-MS	250 MS Sac Gövdeli Aksiyel Fanlar	1	960,00
AIR.300-MS	300 MS Sac Gövdeli Aksiyel Fanlar	1	1.120,00



Sac Gövdeli Kare Aksiyel Fanlar

KOD	CİNSİ	KOLİ	FİYAT
AIR.200-MSK	200 MS Sac Gövdeli Kare Aksiyel Fanlar	1	1.070,00
AIR.250-MSK	250 MS Sac Gövdeli Kare Aksiyel Fanlar	1	1.250,00
AIR.300-MSK	300 MS Sac Gövdeli Kare Aksiyel Fanlar	1	1.550,00



Sac Gövdeli Aksiyel Fanlar

KOD	CİNSİ	KOLİ	FİYAT
AIR.160-BF	160 BF Sac Gövdeli Aksiyel Fan	10	720,00
AIR.200-BF	200 BF Sac Gövdeli Aksiyel Fan	10	775,00
AIR.250-BF	250 BF Sac Gövdeli Aksiyel Fan	10	900,00
AIR.300-BF	300 BF Sac Gövdeli Aksiyel Fan	10	1.080,00
AIR.350-BF	350 BF Sac Gövdeli Aksiyel Fan	10	1.190,00





Aspiratörler

KOD	cinsi	KOLİ	FİYAT
AIR.100	100'lük Aspiratör	10	270,00
AIR.120	120'lik Aspiratör	10	300,00
AIR.150	150'lik Aspiratör	10	378,00
AIR.200	200'lük Aspiratör	10	485,00



Aspiratörler (AIRSAN)

KOD	cinsi	KOLİ	FİYAT
AIR-S.100	100'lük Aspiratör	10	227,00
AIR-S.120	120'lik Aspiratör	10	255,00
AIR-S.150	150'lik Aspiratör	10	340,00
AIR-S.200	200'lük Aspiratör	10	420,00



Mekanik Panjurlu Aspiratörler

KOD	cinsi	KOLİ	FİYAT
AIR.100-MP	100'lük Mekanik Panjurlu Aspiratör	10	275,00
AIR.120-MP	120'lik Mekanik Panjurlu Aspiratör	10	324,00
AIR.150-MP	150'lik Mekanik Panjurlu Aspiratör	10	410,00



Otomatik Panjurlu Aspiratörler

KOD	cinsi	KOLİ	FİYAT
AIR.100-OP	100'lük Otomatik Panjurlu Aspiratör	10	365,00
AIR.120-OP	120'lik Otomatik Panjurlu Aspiratör	10	415,00
AIR.150-OP	150'lik Otomatik Panjurlu Aspiratör	10	505,00



Kanal Tipi Aspiratörler

KOD	cinsi	KOLİ	FİYAT
AIR.100-KT	100'lük Kanal Tipi Aspiratör	10	235,00
AIR.120-KT	120'lik Kanal Tipi Aspiratör	10	275,00
AIR.150-KT	150'lik Kanal Tipi Aspiratör	10	325,00



Kapaklı Aspiratörler

KOD	cinsi	KOLİ	FİYAT
AIR.20-K	20'lik Plastik Gövde Kapaklı Aspiratör	10	520,00
AIR.25-K	25'lik Plastik Gövde Kapaklı Aspiratör	6	625,00



Plastik Gövdeli Aksiyel Fanlar

KOD	cinsi	KOLİ	FİYAT
AIR.300-S	300'lük Sanayi Tipi Aspiratör (Monofaze)	1	1.670,00
AIR.400-S	400'lük Sanayi Tipi Aspiratör (Monofaze)	1	1.910,00
AIR.450-S	450'lik Sanayi Tipi Aspiratör (Monofaze)	1	2.700,00
AIR.500-S	500'lük Sanayi Tipi Aspiratör (Monofaze)	1	2.940,00



0,6/1 Kv Bakır İletkenler İçin Reçineli Kablo Ek Mufları

KOD	cinsi	KOLİ	FİYAT
E1.404-406	4 x 4 - 4 x 6 Reçineli Ek Muf	60	172,50
E1.410	4 x 10 Reçineli Ek Muf	27	266,00
E1.416	4 x 16 Reçineli Ek Muf	27	273,00
E1.425	4 x 25 Reçineli Ek Muf	27	291,00
E1.435	4 x 35 Reçineli Ek Muf	27	304,00
E1.31610	3 x 16 + 10 Reçineli Ek Muf	27	270,00
E1.32516	3 x 25 + 16 Reçineli Ek Muf	27	285,00
E1.33516	3 x 35 + 16 Reçineli Ek Muf	27	299,00
E1.35025	3 x 50 + 25 Reçineli Ek Muf	27	310,00
E1.37035	3 x 70 + 35 Reçineli Ek Muf	18	498,00
E1.39550	3 x 95 + 50 Reçineli Ek Muf	18	522,00
E1.31207	3 x 120 + 70 Reçineli Ek Muf	10	830,00
E1.31507	3 x 150 + 70 Reçineli Ek Muf	10	867,00
E1.31859	3 x 185 + 95 Reçineli Ek Muf	4	1.281,00
E1.32401	3 x 240 + 120 Reçineli Ek Muf	4	1.375,00



E1.404-406



E1.416

Isı Büzüşmeli Ek Muflar (Bakır İletkenler için)

KOD	cinsi	ADET	FİYAT
S1.404-406	4 x 4 - 4 x 6 Isı Büzüşmeli Ek Muf	1	72,40
S1.410	4 x 10 Isı Büzüşmeli Ek Muf	1	89,50
S1.416	4 x 16 Isı Büzüşmeli Ek Muf	1	95,45
S1.425	4 x 25 Isı Büzüşmeli Ek Muf	1	147,20
S1.435	4 x 35 Isı Büzüşmeli Ek Muf	1	157,50
S1.31610	3 x 16 + 10 Isı Büzüşmeli Ek Muf	1	95,45
S1.32516	3 x 25 + 16 Isı Büzüşmeli Ek Muf	1	142,60
S1.33516	3 x 35 + 16 Isı Büzüşmeli Ek Muf	1	154,00
S1.35025	3 x 50 + 25 Isı Büzüşmeli Ek Muf	1	165,60
S1.37035	3 x 70 + 35 Isı Büzüşmeli Ek Muf	1	248,40
S1.39550	3 x 95 + 50 Isı Büzüşmeli Ek Muf	1	271,40
S1.31207	3 x 120 + 70 Isı Büzüşmeli Ek Muf	1	354,20
S1.31507	3 x 150 + 70 Isı Büzüşmeli Ek Muf	1	437,00
S1.31859	3 x 185 + 95 Isı Büzüşmeli Ek Muf	1	711,85
S1.32401	3 x 240 + 120 Isı Büzüşmeli Ek Muf	1	745,20



Fermuarlı Isı Büzüşmeli Ek Muflar

KOD	cinsi	ADET	FİYAT
FS1.404-406	4 x 4 - 4 x 6 Isı Büzüşmeli Ek Muf	1	327,75
FS1.410	4 x 10 Isı Büzüşmeli Ek Muf	1	352,00
FS1.416	4 x 16 Isı Büzüşmeli Ek Muf	1	372,60
FS1.425	4 x 25 Isı Büzüşmeli Ek Muf	1	396,75
FS1.435	4 x 35 Isı Büzüşmeli Ek Muf	1	403,65
FS1.31610	3 x 16 + 10 Isı Büzüşmeli Ek Muf	1	372,60
FS1.32516	3 x 25 + 16 Isı Büzüşmeli Ek Muf	1	390,00
FS1.33516	3 x 35 + 16 Isı Büzüşmeli Ek Muf	1	397,00
FS1.35025	3 x 50 + 25 Isı Büzüşmeli Ek Muf	1	407,00
FS1.37035	3 x 70 + 35 Isı Büzüşmeli Ek Muf	1	521,00
FS1.39550	3 x 95 + 50 Isı Büzüşmeli Ek Muf	1	535,00
FS1.31207	3 x 120 + 70 Isı Büzüşmeli Ek Muf	1	642,00
FS1.31507	3 x 150 + 70 Isı Büzüşmeli Ek Muf	1	665,00
FS1.31859	3 x 185 + 95 Isı Büzüşmeli Ek Muf	1	794,00
FS1.32401	3 x 240 + 120 Isı Büzüşmeli Ek Muf	1	875,00



O.G. Tek Damarlı Isı Büzüşmeli Kablo Ek Mufları

KOD	CİNSİ		KOLİ	FİYAT
IB36.125	1x25+16	Isı Büzüşmeli Ek Muf	20	2.162,00
IB36.135	1x35+16	Isı Büzüşmeli Ek Muf	20	2.162,00
IB36.150	1x50+16	Isı Büzüşmeli Ek Muf	20	2.185,00
IB36.170	1x70+16	Isı Büzüşmeli Ek Muf	20	2.185,00
IB36.195	1x95+16	Isı Büzüşmeli Ek Muf	20	2.185,00
IB36.1120	1x120+16	Isı Büzüşmeli Ek Muf	20	2.208,00
IB36.1150	1x150+25	Isı Büzüşmeli Ek Muf	20	2.208,00
IB36.1185	1x185+25	Isı Büzüşmeli Ek Muf	20	2.237,00
IB36.1240	1x240+25	Isı Büzüşmeli Ek Muf	20	2.237,00
IB36.1300	1x300+25	Isı Büzüşmeli Ek Muf	20	2.440,00
IB36.1400	1x400+35	Isı Büzüşmeli Ek Muf	20	2.542,00
IB36.1500	1x500+35	Isı Büzüşmeli Ek Muf	20	2.778,00
IB36.1630	1x630+35	Isı Büzüşmeli Ek Muf	20	3.065,00



[20.8-36kV]

O.G. Üç Damarlı Isı Büzüşmeli Kablo Ek Mufları

KOD	CİNSİ		KOLİ	FİYAT
IB36.325	3x25+16	Isı Büzüşmeli Ek Muf	20	8.460,00
IB36.335	3x35+16	Isı Büzüşmeli Ek Muf	20	8.460,00
IB36.350	3x50+16	Isı Büzüşmeli Ek Muf	20	8.460,00
IB36.370	3x70+16	Isı Büzüşmeli Ek Muf	20	8.465,00
IB36.395	3x95+16	Isı Büzüşmeli Ek Muf	20	8.465,00
IB36.3120	3x120+16	Isı Büzüşmeli Ek Muf	20	8.476,00
IB36.3150	3x150+25	Isı Büzüşmeli Ek Muf	20	8.476,00
IB36.3185	3x185+25	Isı Büzüşmeli Ek Muf	20	8.516,00
IB36.3240	3x240+25	Isı Büzüşmeli Ek Muf	20	8.568,00
IB36.3300	3x300+25	Isı Büzüşmeli Ek Muf	20	8.700,00
IB36.3400	3x400+35	Isı Büzüşmeli Ek Muf	20	8.792,00
IB36.3500	3x500+35	Isı Büzüşmeli Ek Muf	20	9.030,00



[20.8-36kV]

Protolin & Yenilenebilir Esnek Dolgu Reçineler

KOD	CİNSİ		KOLİ	FİYAT
PRO.210	210 gr.	Protolin	50	57,50
PRO.500	500 gr.	Protolin	45	93,18
PRO.1000	1000 gr.	Protolin	24	166,80
PRO.4000	4000 gr.	Protolin	6	584,30
PRO.20000	20000 gr.	Protolin	1	2.848,00
PSİL.1000	1000 gr.	Prosil	24	208,20
PSİL.4000	4000 gr.	Prosil	6	676,20



Pabuçsuz Kablo Başlıkları

KOD	CİNSİ		KOLİ	FİYAT
PKB.01	PKB. 2x1,5 - 3x50+25		50	70,15
PKB.02	PKB. 3x70+35 - 3x95+50		50	101,25
PKB.03	PKB. 3x120+70 - 3x150+70		32	172,50



İzole Bant & Eriyen Bantlar

KOD	CİNSİ		KOLİ	FİYAT
TE.1401	Eriyen Bant (10kV / 19mm-8mt)		60	6,00 \$
GVN.1401	Eriyen Bant (19mm-8mt)		60	3,40 \$
ÇPM.1970	İzole Bant (19mm-8mt)		500	8,60
ÇPM.1968	Geniş İzole Bant (0,18x50mm - 25mt)		100	4,30 \$



Düz Tip Reçineli Kablo Ek Mufları

KOD	CİNSİ	KOLİ	FİYAT
ŞE1.410	No:1 4x10	40	262,00
ŞE1.416	No:1 4x16	40	262,00
ŞE1.31610	No:1 3x16+10	40	262,00
ŞE1.32516	No:1 3x25+16	40	267,00
ŞE1.33516	No:2 3x35+16	20	625,00
ŞE1.35025	No:2 3x50+25	20	638,00
ŞE1.37035	No:2 3x70+35	20	652,00
ŞE1.39550	No:2 3x95+50	20	732,00
VDE1.31207	No:3 3x120+70 (Vidalı)	1	1.400,00
VDE1.31507	No:3 3x150+70 (Vidalı)	1	1.392,00
VDE1.31859	No:3 3x185+95 (Vidalı)	1	1.392,00
VDE1.32401	No:3 3x240+120 (Vidalı)	1	1.392,00



Y Branşman Vidalı Şeffaf Reçineli Kablo Ek Mufları

KOD	CİNSİ	KOLİ	FİYAT
VYE1.410	No:3 4x10 (Vidalı)	1	555,50
VYE1.416	No:3 4x16 (Vidalı)	1	555,50
VYE1.31610	No:3 3x16+10 (Vidalı)	1	555,50
VYE1.32516	No:3 3x25+16 (Vidalı)	1	578,00
VYE1.33516	No:3 3x35+16 (Vidalı)	1	848,00
VYE1.35025	No:3 3x50+25 (Vidalı)	1	848,00
VYE1.37035	No:3 3x70+35 (Vidalı)	1	860,00
VYE1.39550	No:3 3x95+50 (Vidalı)	1	1.205,00
VYE1.31207	No:3 3x120+70 (Vidalı)	1	1.230,00
VYE1.31507	No:3 3x150+70 (Vidalı)	1	1.984,00
VYE1.31859	No:3 3x185+95 (Vidalı)	1	1.984,00
VYE1.32401	No:3 3x240+120 (Vidalı)	1	1.995,00



T Tip Reçineli Kablo Ek Mufları

KOD	CİNSİ	KOLİ	FİYAT
TE1.410	No:1 4x10	10	713,00
TE1.416	No:1 4x16	10	713,00
TE1.31610	No:1 3x16+10	10	713,00
TE1.32516	No:1 3x25+16	10	746,00
TE1.33516	No:2 3x35+16	10	1.127,00
TE1.35025	No:2 3x50+25	10	1.139,00
TE1.37035	No:2 3x70+35	10	1.150,00
TE1.39550	No:3 3x95+50 (Vidalı)	10	1.708,00
TE1.31207	No:3 3x120+70 (Vidalı)	1	1.739,00
TE1.31507	No:3 3x150+70 (Vidalı)	1	1.760,00
TE1.31859	No:3 3x185+95 (Vidalı)	1	1.783,00
TE1.32401	No:3 3x240+120 (Vidalı)	1	1.805,00





TEKNİK ÖZELLİKLER



KOD	ÖLÇÜ		DARALMADAN ÖNCE		DARALMADAN SONRA		UZUNLUK MAKARA MT.	FİYAT USD/MT. (SİYAH)	KOD	FİYAT USD/MT. (SARI/YEŞİL)
	MM	INCH	İÇ ÇAPI	ÇİDAR KALINLIĞI	İÇ ÇAPI	ÇİDAR KALINLIĞI				
MKR.4015	1	----	2.0 ± 0.3	0.16 ± 0.05	0.70	0.30 ± 0.05	200	0,082 \$		
MKR.4016	1.5	----	2.0 ± 0.3	0.16 ± 0.05	0.80	0.30 ± 0.05	200	0,093 \$		
MKR.4017	2	----	2.5 ± 0.3	0.16 ± 0.05	1.00	0.35 ± 0.05	200	0,111 \$		
MKR.4003	2.4	3/32	3.0 ± 0.3	0.16 ± 0.05	1.50	0.35 ± 0.05	200	0,111 \$	MKR.4102	0,40 \$
MKR.4018	2.5	----	3.0 ± 0.3	0.16 ± 0.05	1.25	0.38 ± 0.05	200	0,144 \$		
MKR.4019	3	----	3.5 ± 0.4	0.20 ± 0.05	1.50	0.38 ± 0.05	200	0,154 \$		
MKR.4004	3.2	1/8	3.5 ± 0.4	0.20 ± 0.05	1.75	0.40 ± 0.05	200	0,154 \$	MKR.4103	0,41 \$
MKR.4020	3.5	----	4.0 ± 0.4	0.20 ± 0.05	1.75	0.40 ± 0.05	200	0,164 \$		
MKR.4021	4	----	4.5 ± 0.4	0.20 ± 0.05	2.00	0.45 ± 0.05	200	0,192 \$		
MKR.4022	4.5	----	4.8 ± 0.4	0.20 ± 0.05	2.00	0.47 ± 0.08	100	0,221 \$		
MKR.4005	4.8	3/16	5.2 ± 0.4	0.20 ± 0.05	2.60	0.47 ± 0.08	100	0,221 \$	MKR.4104	0,42 \$
MKR.4023	5	----	5.5 ± 0.4	0.20 ± 0.05	2.50	0.55 ± 0.08	100	0,241 \$		
MKR.4024	6	----	6.5 ± 0.4	0.22 ± 0.05	3.00	0.55 ± 0.08	100	0,279 \$		
MKR.4006	6.4	1/4	7.0 ± 0.4	0.28 ± 0.05	3.50	0.55 ± 0.08	100	0,279 \$	MKR.4105	0,48 \$
MKR.4025	7	----	7.5 ± 0.4	0.28 ± 0.05	3.50	0.60 ± 0.08	100	0,337 \$		
MKR.4026	8	----	8.5 ± 0.4	0.30 ± 0.08	4.00	0.60 ± 0.08	100	0,337 \$		
MKR.4007	9.5	3/8	10.0 ± 0.5	0.30 ± 0.08	5.00	0.60 ± 0.08	100	0,337 \$	MKR.4106	0,66 \$
MKR.4028	10	----	10.0 ± 0.5	0.30 ± 0.08	5.00	0.60 ± 0.08	100	0,375 \$		
MKR.4008	12.7	1/2	13.0 ± 0.5	0.33 ± 0.10	6.50	0.65 ± 0.08	100	0,433 \$		
MKR.4031	13	----	13.5 ± 0.5	0.33 ± 0.10	6.50	0.65 ± 0.08	100	0,462 \$	MKR.4107	0,96 \$
MKR.4032	14	----	14.5 ± 0.5	0.33 ± 0.10	7.00	0.70 ± 0.08	100	0,539 \$		
MKR.4034	16	4/5	16.5 ± 0.6	0.35 ± 0.12	8.00	0.75 ± 0.08	100	0,722 \$	MKR.4108	1,40 \$
MKR.4036	18	----	19.0 ± 0.6	0.40 ± 0.15	9.00	0.80 ± 0.15	100	0,943 \$		
MKR.4009	19.1	3/4	20.5 ± 0.6	0.40 ± 0.15	10.00	0.80 ± 0.15	100	0,943 \$		
MKR.4038	20	----	20.5 ± 0.6	0.40 ± 0.15	10.00	0.80 ± 0.15	100	1,203 \$	MKR.4109	1,83 \$
MKR.4039	22	----	22.5 ± 0.7	0.45 ± 0.15	12.00	0.95 ± 0.15	100	1,490 \$		
MKR.4010	25.4	1	25.6 ± 0.7	0.45 ± 0.15	12.00	0.95 ± 0.15	50	1,590 \$	MKR.4110	2,65 \$
MKR.4040	30	----	31.5 ± 0.7	0.50 ± 0.15	15.00	0.95 ± 0.15	50	2,070 \$		
MKR.4011	32	1 1/4	33.0 ± 0.7	0.50 ± 0.15	16.50	0.95 ± 0.15	50	2,070 \$	MKR.4111	3,56 \$
MKR.4041	35	----	38.0 ± 0.7	0.50 ± 0.15	16.00	1.00 ± 0.15	50	2,600 \$		
MKR.4012	38	1 1/2	40.0 ± 0.7	0.50 ± 0.15	20.00	1.00 ± 0.15	50	2,900 \$	MKR.4112	4,81 \$
MKR.4042	40	----	40.5 ± 0.7	0.50 ± 0.15	20.00	1.00 ± 0.15	50	2,900 \$		
MKR.4013	51	2	52.5 ± 0.7	0.50 ± 0.15	25.00	1.00 ± 0.15	50	3,660 \$	MKR.4113	6,75 \$
MKR.4043	60	----	60.5 ± 0.8	0.52 ± 0.15	30.00	1.00 ± 0.16	50	4,910 \$	MKR.4114	9,65 \$
MKR.4044	70	----	70.5 ± 1.0	0.55 ± 0.15	40.00	1.10 ± 0.18	50	6,550 \$		
MKR.4045	80	----	82.0 ± 1.0	0.55 ± 0.15	40.00	1.10 ± 0.18	50	7,220 \$	MKR.4115	14,45 \$
MKR.4050	90	4	90.0 ± 1.0	0.55 ± 0.15	45.00	1.10 ± 0.18	50	8,200 \$		
MKR.4046	102	----	105.0 ± 1.0	0.55 ± 0.15	51.00	1.10 ± 0.18	50	9,150 \$	MKR.4116	22,20 \$
MKR.4047	120	----	120.0 ± 1.0	0.55 ± 0.15	60.00	1.10 ± 0.18	50	12,550 \$		
MKR.4048	150	----	150.0 ± 1.0	0.55 ± 0.15	76.00	1.10 ± 0.18	50	18,300 \$		
MKR.4049	180	----	180.0 ± 1.0	0.55 ± 0.15	90.00	1.10 ± 0.18	50	26,000 \$		

Malzeme: Polyolefin **Daralma Oranı:** 2/1 **Yanmazlık:** Kendi kendine söner **Çalışma Sıcaklığı:** -55 C...+125 C

Tenpo



TNP.280

1/16A
Kauçuk Düz Fiş
Kutu Adedi: 50

14,00 TL



TNP.270

1/16A
Kauçuk Eğik Fiş
Kutu Adedi: 50

14,00 TL



TNP.290

1/16A
Kauçuk Seyyar Priz
Kutu Adedi: 30

17,10 TL



TNP.292

1/16A
Kauçuk 2li Grup Priz
Kutu Adedi: 15

46,00 TL



TNP.293

1/16A
Kauçuk 3lü Grup Priz
Kutu Adedi: 12

54,20 TL



TNP.298

1/16A
Pano Priz
Kutu Adedi: 50

15,50 TL



TNP.299

1/16A
Makine Priz
Kutu Adedi: 30

18,50 TL



TNP.296

1/16A
Kauçuk Duvar Priz
Kutu Adedi: 24

18,50 TL



FP.10008

3/25A
Plastik Erkek Fiş
Kutu Adedi: 20

33,80 TL



FP.10009

3/25A
Plastik Duvar Priz
Kutu Adedi: 12

45,00 TL



TNP.300

3/25A
Kauçuk Düz Fiş
Kutu Adedi: 40

28,00 TL



TRİ.202

3/25A
Plastik Düz Fiş
Kutu Adedi: 24

27,50 TL



TNP.310

3/25A
Kauçuk Seyyar Priz
Kutu Adedi: 30

37,00 TL



TNP.315

3/25A
Kauçuk Duvar Priz
Kutu Adedi: 18

51,50 TL



TNP.318

3/25A
Makine Priz
Kutu Adedi: 30

30,00 TL



TNP.311

1x1/16A + 1x3/25A
Kauçuk 2li Grup Priz
Kutu Adedi: 12

85,50 TL



TNP.312

3/25A
Kauçuk 2li Grup Priz
Kutu Adedi: 12

97,00 TL



TNP.313

3/25A
Kauçuk 3lü Grup Priz
Kutu Adedi: 12

119,00 TL



TNP.316

1x1/16A + 2x3/25A
Kauçuk 3lü Grup Priz
Kutu Adedi: 12

115,00 TL



TNP.317

2x1/16A + 1x3/25A
Kauçuk 3lü Grup Priz
Kutu Adedi: 12

115,00 TL



MS.118

Seyyar El Lambası
Anahtarlı
Kutu Adedi: 10

97,00 TL



MS.119

Seyyar El Lambası
Anahtarlı 7 mt Kablolu
Kutu Adedi: 6

302,00 TL



MS.120

Seyyar El Lambası
Anahtarsız
Kutu Adedi: 10

93,00 TL



MS.121

Seyyar El Lambası
Anahtarsız 7 mt Kablolu
Kutu Adedi: 6

290,00 TL

Monofaze Fiş & Prizler (3/16A.)

KOD	CİNSİ	KUTU	FİYAT
MON.250	3/16A. Pls. Düz Fiş	20	65,00
MON.251	3/16A. Pls. Seyyar Priz (HJ.213)	20	79,00
MON.252	3/16A. Pls. Makine Priz	24	72,50
MON.253	3/16A. Pls. Düz Duvar Priz	18	93,50
MON.254	3/16A. Pls. Eğik Duvar Priz	8	106,80

CEE Norm



MON.250



MON.252



MON.254

Trifaze Fiş & Prizler (4/16A. - 4/32A.)

KOD	CİNSİ	KUTU	FİYAT
TRİ.300	4/16A. Pls. Düz Fiş (HJ.014)	20	78,80
TRİ.301	4/16A. Pls. Seyyar Priz (HJ.214)	16	92,40
TRİ.302	4/16A. Pls. Makine Priz	18	91,50
TRİ.303	4/16A. Pls. Düz Duvar Priz	12	116,50
TRİ.304	4/16A. Pls. Eğik Duvar Priz	8	134,40
TRİ.310	4/32A. Pls. Düz Fiş	12	108,60
TRİ.311	4/32A. Pls. Seyyar Priz	12	126,00



TRİ.300



TRİ.301



TRİ.302



TRİ.303



TRİ.304

Trifaze Fiş & Prizler (5/16A. - 5/32A. - 5/63A.)

KOD	CİNSİ	KUTU	FİYAT
TRİ.305	5/16A. Pls. Düz Fiş	12	87,10
TRİ.306	5/16A. Pls. Seyyar Priz	10	105,00
TRİ.307	5/16A. Pls. Makine Priz	18	94,00
TRİ.308	5/16A. Pls. Düz Duvar Priz	12	116,50
TRİ.309	5/16A. Pls. Eğik Duvar Priz	8	145,50
TRİ.315	5/32A. Pls. Düz Fiş	12	114,40
TRİ.316	5/32A. Pls. Seyyar Priz	8	136,40
TRİ.317	5/32A. Pls. Makine Priz	12	119,00
TRİ.318	5/32A. Pls. Düz Duvar Priz	10	140,70
TRİ.319	5/32A. Pls. Eğik Duvar Priz	8	169,00
TRİ.324	5/63A. Pls. Düz Fiş (HJ.035)	2	546,00
TRİ.325	5/63A. Pls. Seyyar Priz (HJ.235)	2	735,00
TRİ.326	5/63A. Pls. Makine Priz	4	712,00
TRİ.327	5/63A. Pls. Eğik Duvar Priz	2	1.074,00



TRİ.305



TRİ.306



TRİ.307



TRİ.308



TRİ.309



TRİ.315



TRİ.316



TRİ.317



TRİ.327

Yassı Fiş & Prizler

KOD	CİNSİ	KUTU	FİYAT
YT.400	16/25A. Yassı Düz Fiş	16	62,00
YT.401	16/25A. Yassı Seyyar Priz	16	80,00
YT.402	16/25A. Yassı Duvar Priz	16	83,00
YT.403	25/40A. Yassı Düz Fiş	10	125,00
YT.404	25/40A. Yassı Seyyar Priz	10	151,00
YT.405	25/40A. Yassı Duvar Priz	10	156,50



YT.400



YT.401



YT.402

Plastik & Metal Makaralar

KOD	CİNSİ	KUTU	FİYAT
MAK.420	25 Mt. Kap. Pls. Makara 4-1/16A.	6	252,00
MAK.421	50 Mt. Kap. Pls. Makara 4-1/16A.	5	289,00
MAK.432	50 Mt. Kap. Metal Makara 4-1/16A.	5	420,00
MAK.422	25 MT. 3x1.5 Kap. Boş Pls. Makara	1	226,00



MAK.420



MAK.432



MAK.422



BK1-1402-2011

1/16A Kauçuk Düz Fiş
Kutu Adedi: 30
32,30 TL



BK1-1402-2021

1/16A Kulplu Eğik Fiş
Kutu Adedi: 20
41,55 TL



BK1-1402-2311

1/16A Uzatma Priz
Kutu Adedi: 25
47,25 TL



BY8-1402-2700

1/16A Pano Priz
Kutu Adedi: 30
37,00 TL



BK1-1402-3511

1/16A Duvar Priz
Kutu Adedi: 12
57,40 TL



BK1-1402-3612

1/16A İkili Grup Priz
Kutu Adedi: 8
98,35 TL



BK1-1402-3613

1/16A Üçlü Grup Priz
Kutu Adedi: 7
112,00 TL



BK1-1402-3614

1/16A Dörtlü Grup Priz
Kutu Adedi: 8
128,95 TL



BY8-1402-3510

1/16A Duvar Kasalı Pano Priz
Kutu Adedi: 12
66,15 TL



BP1-1402-2410

1/16A Makine Priz
Kutu Adedi: 18
46,30 TL



BP1-1402-2510

1/16A Duvar Priz
Kutu Adedi: 6
72,75 TL



BR1-1402-2711

1/16A 220V Ray Priz
Kutu Adedi: 12
76,40 TL



BR1-2504-2711

3/25A 380V Ray Priz
Kutu Adedi: 6
90,10 TL



BK1-2504-4023

3/25A Kauçuk Eğik Fiş
Kutu Adedi: 16
67,75 TL



BK1-2504-4011

3/25A Kauçuk Düz Fiş
Kutu Adedi: 20
48,10 TL



BK1-2504-4012

3/25A Kauçuk Düz Fiş
Kutu Adedi: 20
45,90 TL



BP2-2504-4415

3/25A Makine Priz
Kutu Adedi: 18
60,00 TL



BP2-2504-4516

3/25A Duvar Priz
Kutu Adedi: 6
90,10 TL



BK1-2504-4314

3/25A Kauçuk Uzatma Priz
Kutu Adedi: 15
74,30 TL



BK6-2504-4511

3/25A Kauçuk Duvar Priz
Kutu Adedi: 14
91,80 TL



BK6-2504-4611

1/16A + 3/25A
Kauçuk 2'li Grup Priz
Kutu Adedi: 5
163,90 TL



BK6-2504-4612

3/25A Kauçuk
2li Grup Priz
Kutu Adedi: 5
168,25 TL



BK6-2504-4613

2x1/16A + 3/25A
Kauçuk 3'lü Grup Priz
Kutu Adedi: 6
218,50 TL



BK6-2504-4614

1/16A + 2x3/25A
Kauçuk 3'lü Grup Priz
Kutu Adedi: 6
229,45 TL



BK6-2504-4615

3/25A
Kauçuk 3'lü Grup
Kutu Adedi: 6
240,35 TL



BK6-2504-4616

2x1/16A + 2x3/25A
Kauçuk 4'lü Grup Priz
Kutu Adedi: 8
240,35 TL



BK6-2504-4617

1x1/16A + 3x3/25A
Kauçuk 4'lü Grup Priz
Kutu Adedi: 8
251,30 TL



BK6-2504-4618

3/25A
Kauçuk 4'lü Grup Priz
Kutu Adedi: 8
262,20 TL

**BY1-1504-2011**16/25A Yassı Düz Fiş
Kutu Adedi: 15
77,50 TL**BY1-1504-2311**16/25A Yassı Uzatma Priz
Kutu Adedi: 15
99,00 TL**BY1-1504-2511**16/25A Yassı Duvar Priz
Kutu Adedi: 12
99,00 TL**BY1-2504-2011**25/40A Yassı Düz Fiş
Kutu Adedi: 12
108,00 TL**BY1-2504-2311**25/40A Yassı Uzatma Priz
Kutu Adedi: 8
120,00 TL**BY1-2504-2511**25/40A Yassı Duvar Priz
Kutu Adedi: 7
120,00 TL**BY1-4504-2011**40/63A Yassı Düz Fiş
Kutu Adedi: 8
163,00 TL**BY1-4504-2511**40/63A Yassı Duvar Priz
Kutu Adedi: 4
187,00 TL**BK4-7501-2010**16/95 mm² 200A.
Ark Fiş
Kutu Adedi: 15
171,00 TL**BK4-7501-2310**16/95 mm² 200A.
Uzatma Priz
Kutu Adedi: 15
175,60 TL**BK4-7501-2410**16/95 mm² 200A.
Makine Priz
Kutu Adedi: 12
225,75 TL**BK4-9501-2010**50/150 mm² 400A.
Ark Fiş
Kutu Adedi: 15
193,80 TL**BK4-9501-2310**50/150 mm² 400A.
Uzatma Priz
Kutu Adedi: 15
216,60 TL**BK4-9501-2410**50/150 mm² 400A.
Makine Priz
Kutu Adedi: 12
250,80 TL**BC1-1403-2011**CEE Norm 3/16A Düz Fiş
Kutu Adedi: 10
72,80 TL**BC1-1403-2312**CEE Norm 3/16A Uzatma Priz
Kutu Adedi: 10
95,70 TL**BC1-1403-2413**CEE Norm 3/16A Makine Priz
Kutu Adedi: 15
89,65 TL**BC1-1403-2510**CEE Norm 3/16A Duvar Priz
Kutu Adedi: 6
132,40 TL**BC1-3403-2011**CEE Norm 3/32A Düz Fiş
Kutu Adedi: 8
117,25 TL**BC1-3403-2312**CEE Norm 3/32A Uzatma Priz
Kutu Adedi: 8
142,85 TL**BC1-3403-2413**CEE Norm 3/32A Makine Priz
Kutu Adedi: 8
131,05 TL**BC1-3403-2510**CEE Norm 3/32A Duvar Priz
Kutu Adedi: 6
190,00 TL



BC1-1504-2011

CEE Norm 4/16A
Düz Fiş
Kutu Adedi: 8
85,60 TL



BC1-1504-2312

CEE Norm 4/16A
Uzatma Priz
Kutu Adedi: 8
115,55 TL



BC1-1504-2413

CEE Norm 4/16A
Makine Priz
Kutu Adedi: 15
105,80 TL



BC1-1504-2510

CEE Norm 4/16A
Duvar Priz
Kutu Adedi: 6
141,15 TL



BC1-1504-2535

CEE Norm 4/16A
90° Eğik Duvar Priz
Kutu Adedi: 3
174,85 TL



BC1-3504-2011

CEE Norm 4/32A
Düz Fiş
Kutu Adedi: 8
122,00 TL



BC1-3504-2312

CEE Norm 4/32A
Uzatma Priz
Kutu Adedi: 8
160,00 TL



BC1-3504-2413

CEE Norm 4/32A
Makine Priz
Kutu Adedi: 8
146,25 TL



BC1-3504-2510

CEE Norm 4/32A
Duvar Priz
Kutu Adedi: 6
195,75 TL



BC1-3504-2535

CEE Norm 4/32A
90° Eğik Duvar Priz
Kutu Adedi: 3
230,10 TL



BC1-4504-2011

CEE Norm 4/63A
Düz Fiş
Kutu Adedi: 1
445,00 TL



BC1-4504-2312

CEE Norm 4/63A
Uzatma Priz
Kutu Adedi: 1
661,65 TL



BC1-4504-2413

CEE Norm 4/63A
Makine Priz
Kutu Adedi: 1
450,05 TL



BC1-4504-2510

CEE Norm 4/63A
Duvar Priz
Kutu Adedi: 1
596,00 TL



BC1-4504-2535

CEE Norm 4/63A
90° Eğik Duvar Priz
Kutu Adedi: 1
717,90 TL



BC1-6504-7011

CEE Norm 4/125A
Düz Fiş (IP 67)
Kutu Adedi: 1
1.510,50 TL



BC1-6504-7312

CEE Norm 4/125A
Uzatma Priz (IP 67)
Kutu Adedi: 1
1.542,50 TL



BC1-6504-7413

CEE Norm 4/125A
Makine Priz (IP 67)
Kutu Adedi: 1
1.491,00 TL



BC1-6504-7114

CEE Norm 4/125A
Makine Fiş (IP 67)
Kutu Adedi: 1
1.491,00 TL



BT4-1001-0007

80mm x 80mm x 60mm
1'li Alümi. Buton Kutusu (IP67)
Kutu Adedi: 1
247,00 TL



BT4-1001-0017

80mm x 80mm x 73mm
1'li Alümi. Buton Kutusu (IP67)
Kutu Adedi: 1
259,50 TL



BT4-2001-0007

80mm x 130mm x 73mm
2'li Alümi. Buton Kutusu (IP67)
Kutu Adedi: 1
322,00 TL



BT4-3001-0007

80mm x 170mm x 73mm
3'lü Alümi. Buton Kutusu (IP67)
Kutu Adedi: 1
382,00 TL



BT4-3001-0017

80mm x 170mm x 73mm
4'lü Alümi. Buton Kutusu (IP67)
Kutu Adedi: 1
390,00 TL



BB3-2131-0087

80mm x 80mm x 60mm
Alüminyum Buat (IP67)
Kutu Adedi: 1
187,00 TL



BB3-2131-0097

80mm x 80mm x 73mm
Alüminyum Buat (IP67)
Kutu Adedi: 1
210,00 TL



BB3-2231-0097

80mm x 130mm x 72mm
Alüminyum Buat (IP67)
Kutu Adedi: 1
295,00 TL



BB3-2331-0097

80mm x 170mm x 73mm
Alüminyum Buat (IP67)
Kutu Adedi: 1
334,50 TL



BB3-2431-0097

80mm x 230mm x 73mm
Alüminyum Buat (IP67)
Kutu Adedi: 1
516,00 TL

**BC1-1505-2011**

CEE Norm 5/16A
Düz Fiş
Kutu Adedi: 8
105,45 TL

**BC1-1505-2312**

CEE Norm 5/16A
Uzatma Priz
Kutu Adedi: 8
139,15 TL

**BC1-1505-2413**

CEE Norm 5/16A
Makine Priz
Kutu Adedi: 15
132,75 TL

**BC1-1505-2510**

CEE Norm 5/16A
Duvar Priz
Kutu Adedi: 6
180,90 TL

**BC1-1505-2535**

CEE Norm 5/16A
90° Eğik Duvar Priz
Kutu Adedi: 3
200,45 TL

**BC1-3505-2011**

CEE Norm 5/32A
Düz Fiş
Kutu Adedi: 8
136,00 TL

**BC1-3505-2312**

CEE Norm 5/32A
Uzatma Priz
Kutu Adedi: 8
172,15 TL

**BC1-3505-2413**

CEE Norm 5/32A
Makine Priz
Kutu Adedi: 8
164,75 TL

**BC1-3505-2510**

CEE Norm 5/32A
Duvar Priz
Kutu Adedi: 6
201,10 TL

**BC1-3505-2535**

CEE Norm 5/32A
90° Eğik Duvar Priz
Kutu Adedi: 3
251,30 TL

**BC1-4505-2011**

CEE Norm 5/63A
Düz Fiş
Kutu Adedi: 1
546,40 TL

**BC1-4505-2312**

CEE Norm 5/63A
Uzatma Priz
Kutu Adedi: 1
750,00 TL

**BC1-4505-2413**

CEE Norm 5/63A
Makine Priz
Kutu Adedi: 1
580,45 TL

**BC1-4505-2510**

CEE Norm 5/63A
Duvar Priz
Kutu Adedi: 1
715,15 TL

**BC1-4505-2535**

CEE Norm 5/63A
90° Eğik Duvar Priz
Kutu Adedi: 1
846,20 TL

**BC1-6505-7011**

CEE Norm 5/125A
Düz Fiş (IP 67)
Kutu Adedi: 1
1.540,00 TL

**BC1-6505-7312**

CEE Norm 5/125A
Uzatma Priz (IP 67)
Kutu Adedi: 1
1.578,00 TL

**BC1-6505-7413**

CEE Norm 5/125A
Makine Priz (IP 67)
Kutu Adedi: 1
1.527,90 TL

**BC1-6505-7114**

CEE Norm 5/125A
Makine Fiş (IP 67)
Kutu Adedi: 1
1.527,90 TL

**BG4-100Y-0Y0Y**

Tribox Grup Priz
(Boş Büyük Delikli)
Kutu Adedi: 2
198,45 TL

**BG4-1010-1010**

1/16A 220V. 3 Ad.
Tribox Grup Priz
Kutu Adedi: 1
454,15 TL

**BG4-1016-1610**

5/16A. 2 Ad.+1/16A. 1 Ad.
Tribox Grup Priz
Kutu Adedi: 1
688,70 TL

**BG4-1019-1910**

5/32A. 2 Ad.+1/16A. 1 Ad.
Tribox Grup Priz
Kutu Adedi: 1
749,50 TL

**BG4-1019-1914**

5/32A. 2 Ad.+3/16A. 1 Ad.
Tribox Grup Priz
Kutu Adedi: 1
783,45 TL

**BB3-2531-0107**

100mm x 100mm x 75mm
Alüminyum Buat (IP67)
Kutu Adedi: 1
232,00 TL

**BB3-2631-0047**

130mm x 130mm x 90mm
Alüminyum Buat (IP67)
Kutu Adedi: 1
529,00 TL

**BB3-2731-0047**

130mm x 190mm x 90mm
Alüminyum Buat (IP67)
Kutu Adedi: 1
640,00 TL

**BB3-2831-0047**

170mm x 190mm x 90mm
Alüminyum Buat (IP67)
Kutu Adedi: 1
780,00 TL

**BB3-2931-0047**

190mm x 250mm x 90mm
Alüminyum Buat (IP67)
Kutu Adedi: 1
1.316,00 TL



BM8-2103-0000

3x1.5 TTR 25m. Kapasiteli
Plastik Makara
Kutu Adedi: 1
353,95 TL



BM9-3103-0000

3x1.5 TTR 50m. Kapasiteli
Plastik Makara
Kutu Adedi: 1
367,15 TL



BM1-2103-0000

3x1.5 TTR 25m. Kapasiteli
Metal Makara
Kutu Adedi: 1
479,20 TL



BM2-3103-0000

3x1.5 TTR 50m. Kapasiteli
Metal Makara
Kutu Adedi: 1
525,00 TL



BM3-4303-0000

3x2.5 TTR 50m. Kapasiteli
Metal Makara
3x1/16A
Kutu Adedi: 1
651,30 TL



BM4-5203-1060

5x2.5 TTR 40m. Kapasiteli
Metal Mak.
2x1/16A + 1x3/25A
Kutu Adedi: 1
962,00 TL



BM4-5103-2060

5x2.5 TTR 40m. Kapasiteli
Metal Makara
1x1/16 + 2x3/25A
Kutu Adedi: 1
1.010,00 TL



BM6-7103-2060

5x2,5 TTR 100m. Kapasiteli
Metal Arabalı Makara
1x1/16 + 2x3/25A
Kutu Adedi: 1
1.885,00 TL



BM1K2103-0000

3x1.5 TTR 25m. KABLONU
Metal Makara 4x1/16A
Kutu Adedi: 1
Fiyat Sorunuz



BM2K3103-0000

3x1.5 TTR 50m. KABLONU
Metal Makara 4x1/16A
Kutu Adedi: 1
Fiyat Sorunuz



BA1-1001-0001

Seyyar El Lambası
Anahtarlı
Kutu Adedi: 1
205,00 TL



BA1-2001-0001

Seyyar El Lambası
Anahtarsız
Kutu Adedi: 1
190,00 TL



BA1-1001-1031

Seyyar El Lambası
Anahtarlı 7.5m Kablolu
Kutu Adedi: 1
342,00 TL



BA1-2001-1031

Seyyar El Lambası
Anahtarsız 7.5m Kablolu
Kutu Adedi: 1
323,00 TL



220 x 130 x 115

6 W. Otomat Kapasiteli
Kombinasyon Kutusu



250 x 190 x 120

11 W. Otomat Kapasiteli
Kombinasyon Kutusu



365 x 185 x 100

Monofaze
Sayaç Kutusu



48 Otomat Kapasiteli
Zayıf Akım Kutusu



32 Otomat Kapasiteli
Zayıf Akım Kutusu



Kablo Toplama Spirali



Yetkili Bayii

